

Sandwich



DETAILLØSNINGER OG STANDARD INDDÆKNINGER

Kan også bruges som Bestillingsliste

NP
NORDIC PANELS

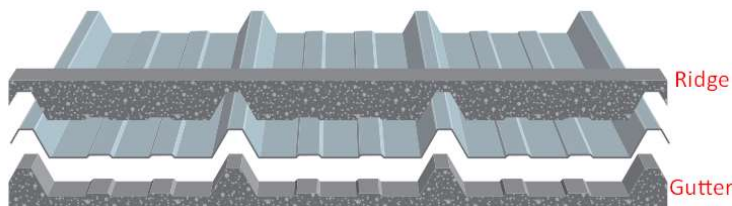

Skumklods

Stk.	Profil	Ridge/Gutter*

***Ridge** = under rygning

* **Gutter** = under cutback tagfod uden udhæng

Diverse tætningsbånd

Alutape - butyl 75mm (Uden på Panelsamlinger facader)

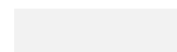

Meter

PU-Bånd 4x80mm (På spærben/søjler bag facadepaneler og evt på tagåse under længesamlinger)

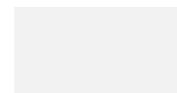

Meter

1,5x15mm butyl tape (længdesamling tagpanel - 2 striber under cutback)

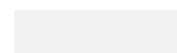

Meter

Rep Maling



RAL
RAL
RAL
RAL

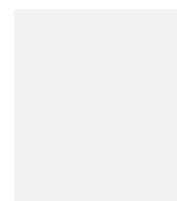
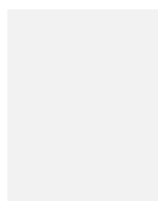

Stk
Stk
Stk
Stk

Befæstelse

Beskrivelse

Beskrivelse	Stk	Art number	RAL
Panelskruer til xxxmm Tagpaneler			
Panelskruer til xxxmm facadepaneler			
Panelskruer til xxxmm facadepaneler			
Panelskruer til xxxmm facadepaneler			
M16 bolt med mørtik og skive (åse)		Bolt M16x35	
Skrue tag sideoverlæg og inddækninger tag		P15048200PL	
Skrue inddækninger facader (Torx 20)		P14020PH	
Skrue indiv kantdele (Torx 20)		P14020PH	

700 - Endeluk paneler udv. hjørner

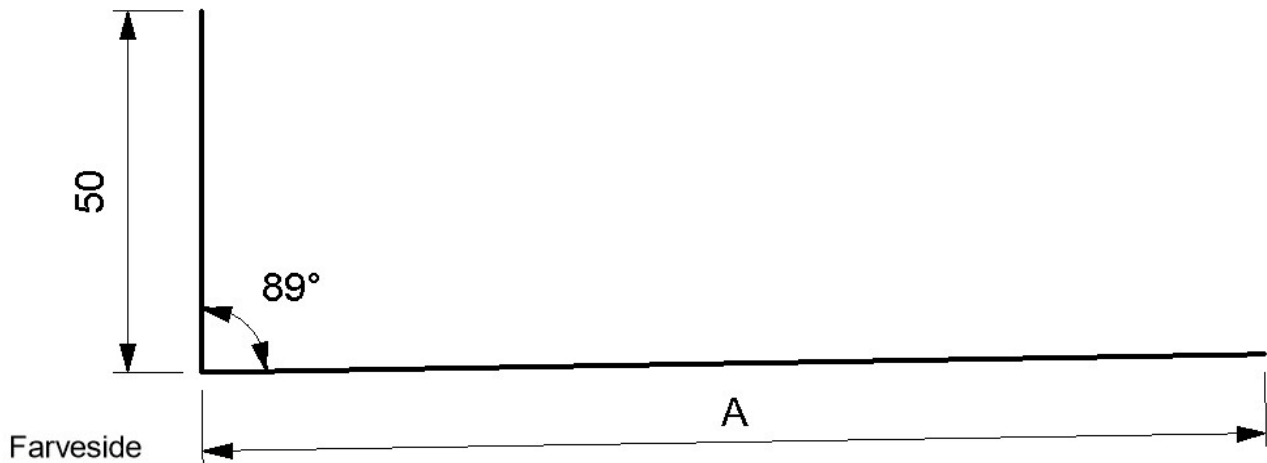
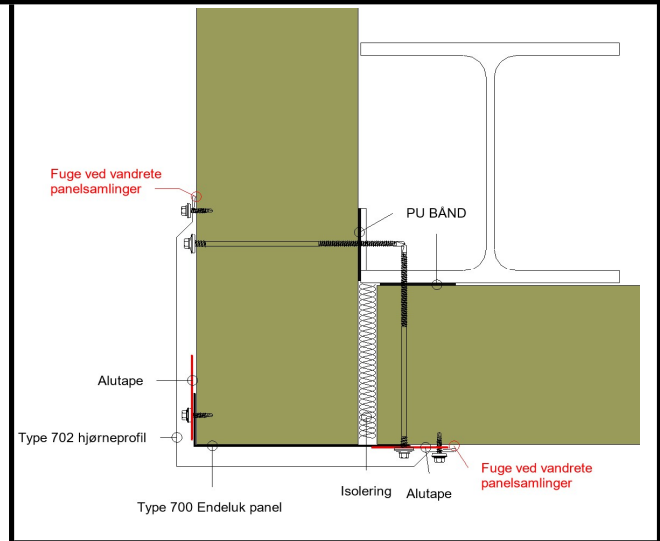

A:

A = paneltykkelse + 40mm

Antal	Længde	Farve	Ståltykkelse	Info til kunde
			0,50	

701 - Søjlemarkering

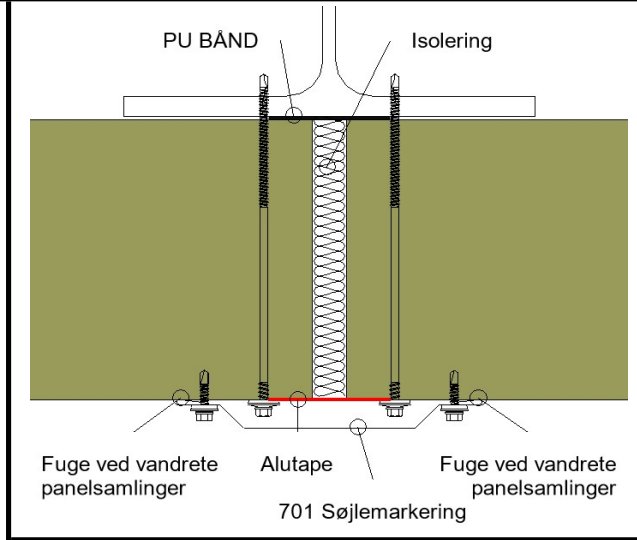
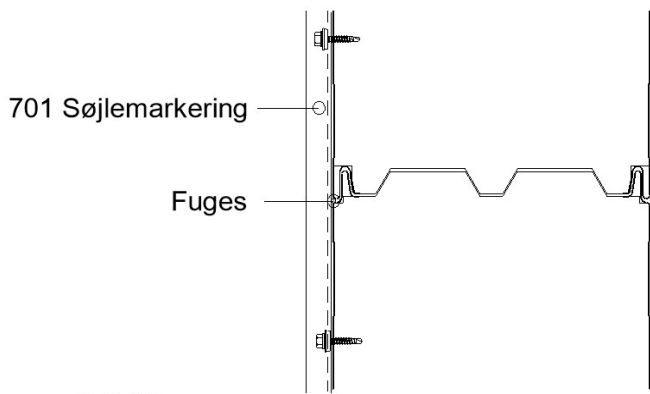

OBS!
Fuges mellem inddækningsflanger og panel ved alle vandrette panelsamlinger!

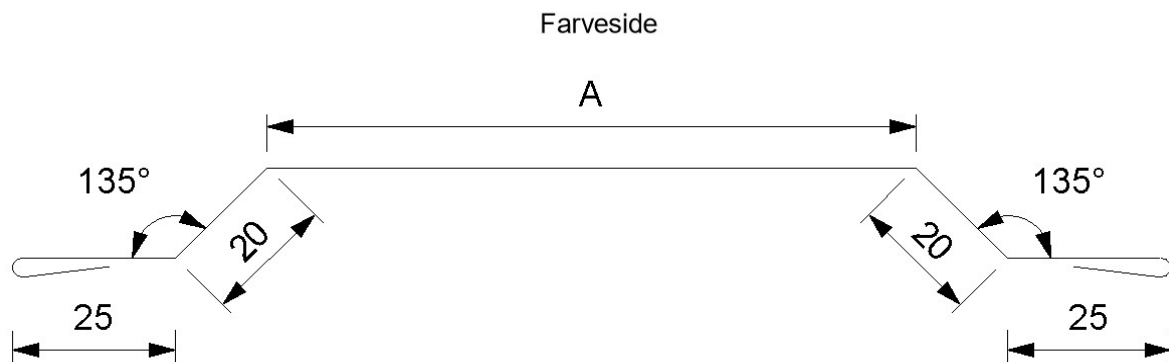

A: 150
(A= STD 150mm)

Antal	Længde	Farve	Ståltykkelse	Info til kunde
			0,50	

702 - Udv. Kassehjørne

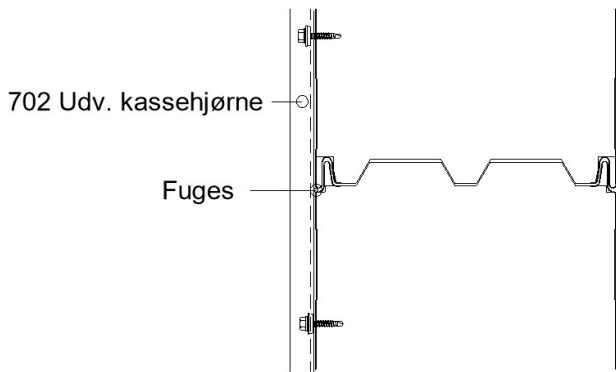

OBS!
Fuges mellem inddækningsflanger og panel ved alle vandrette panelsamlinger!

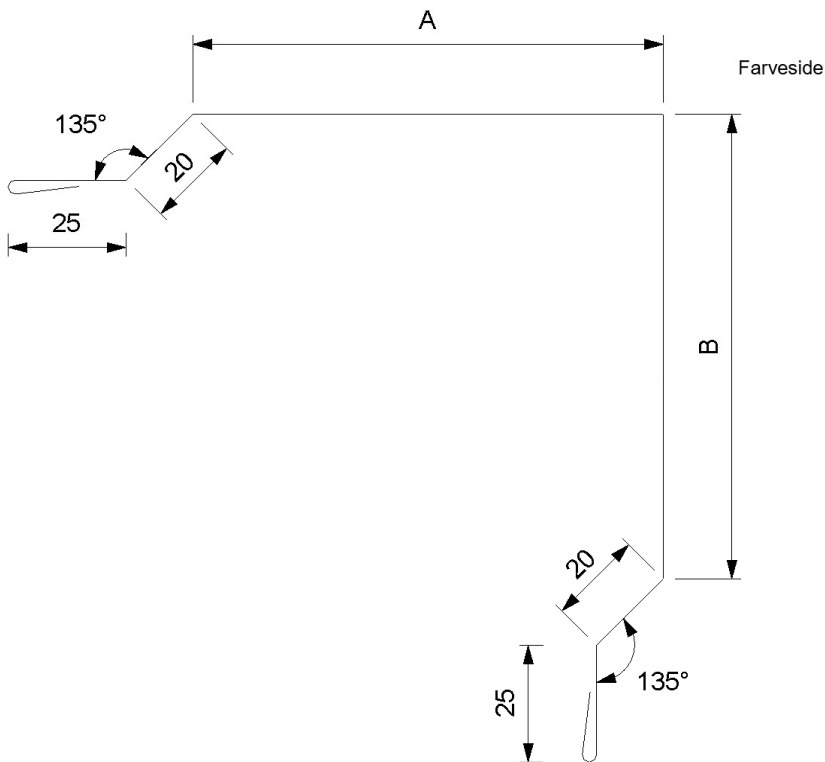
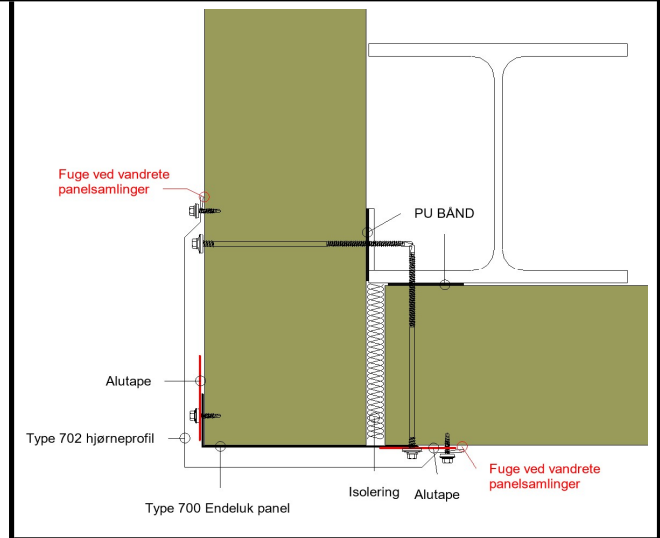

A:

B:

A & B=Paneltykkelse +80mm

Antal	Længde	Farve	Ståltykkelse	Info til kunde
			0,50	

702-B - Udv. Kassehjørne (Anbefales ved paneltykkelser over 160mm)

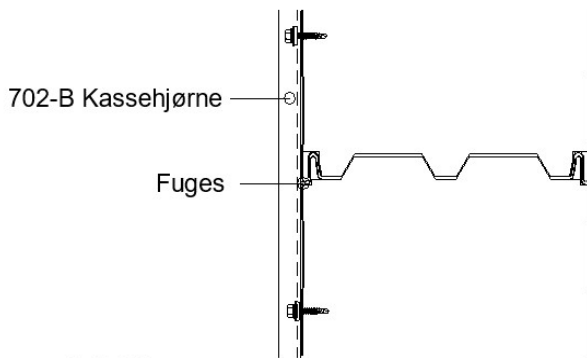

OBS!
Fuges mellem inddækningsflanger og panel ved alle vandrette panelsamlinger!

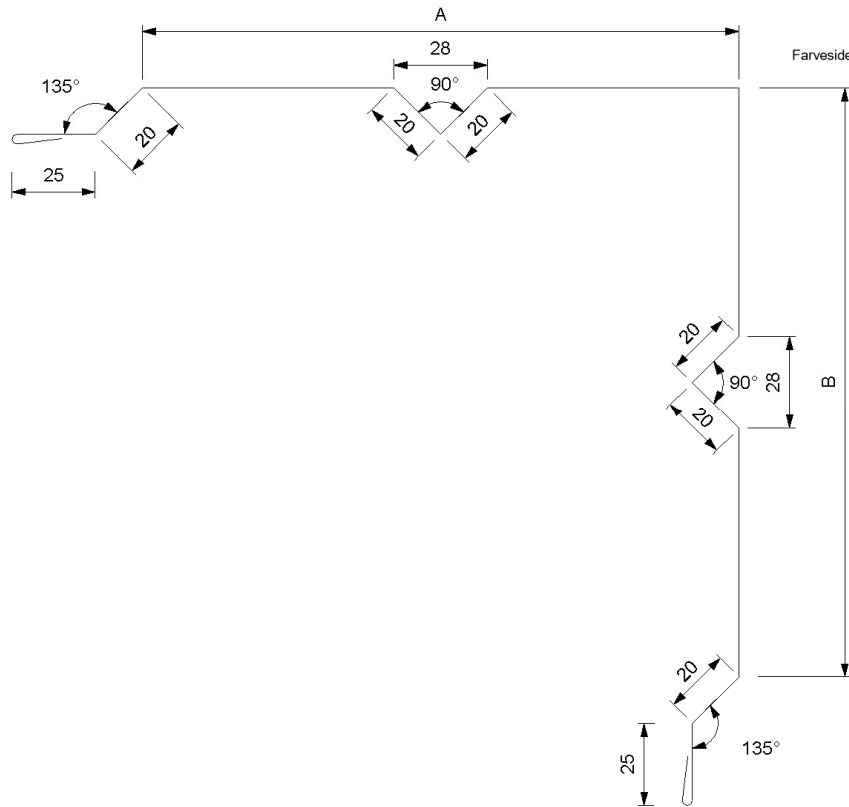
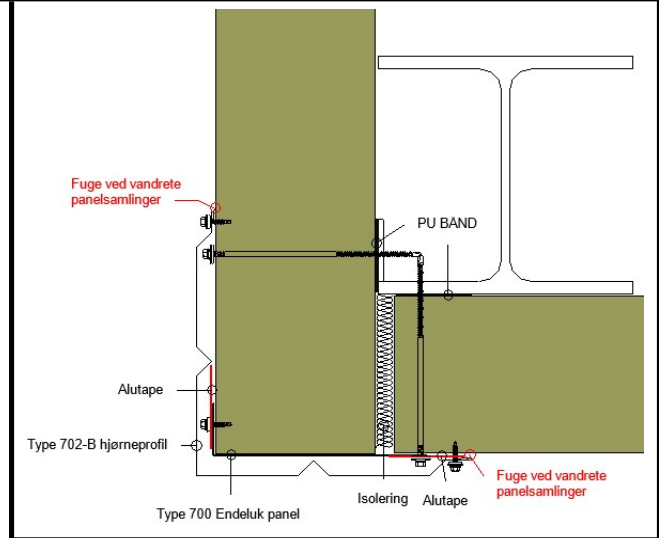

A:

B:

A & B=Paneltykkelse +80mm

Antal	Længde	Farve	Ståltykkelse	Info til kunde
			0,50	

703 - Indv. Kassehjørne

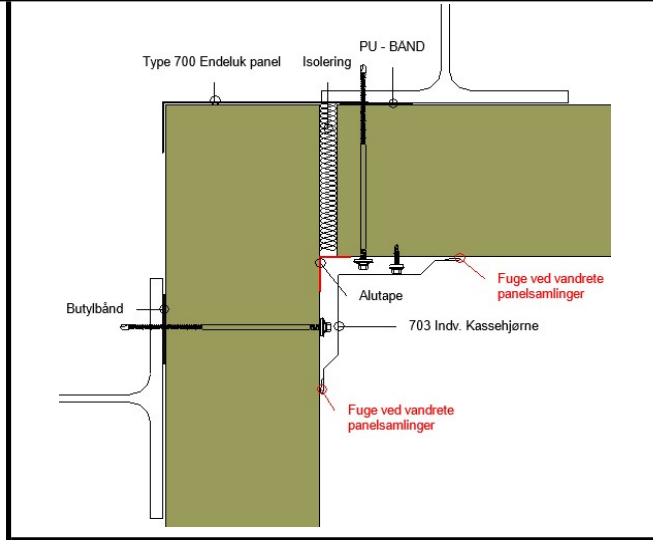
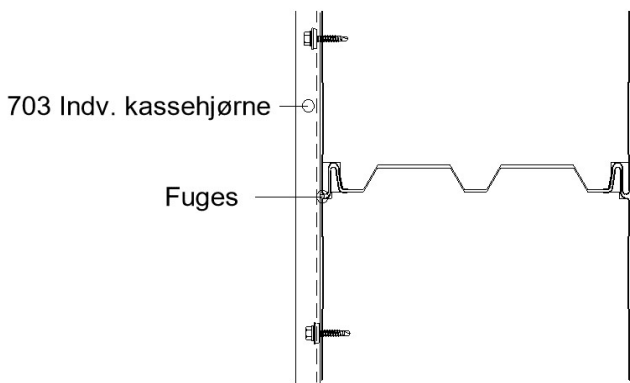

OBS!
Fuges mellem inddækningsflanger og panel ved alle vandrette panelsamlinger!

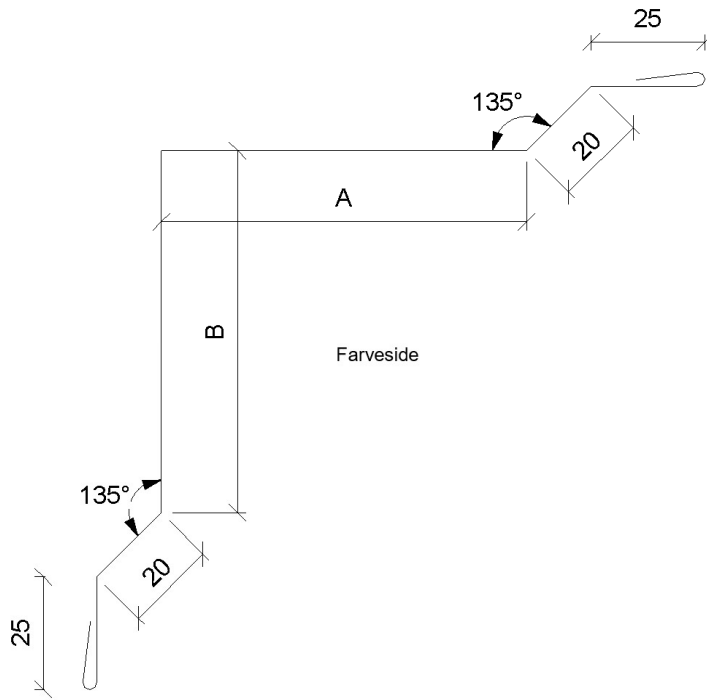

A: 80
B: 80

Antal	Længde	Farve	Ståltykkelse	Info til kunde
			0,50	

704 - Indv. hjørne med 1/forsætning

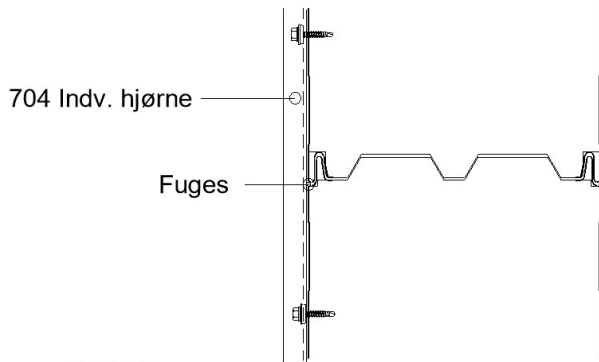

OBS!
Fuges mellem inddækningsflanger og panel ved alle vandrette panelsamlinger!

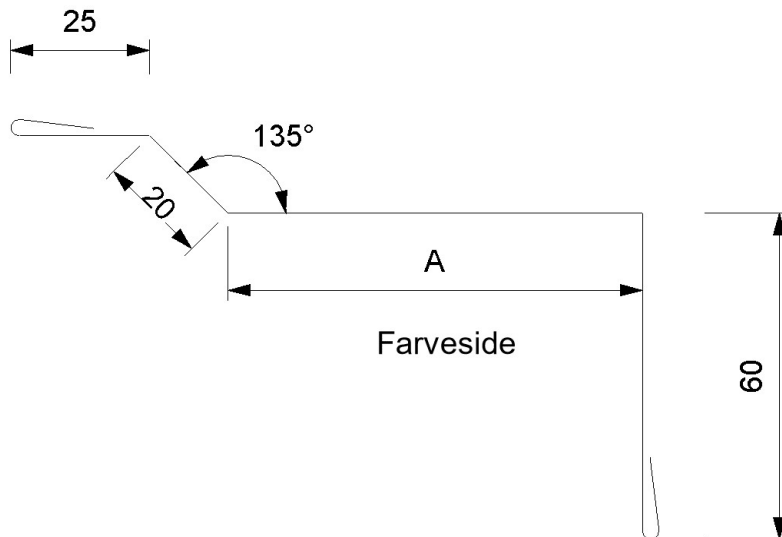
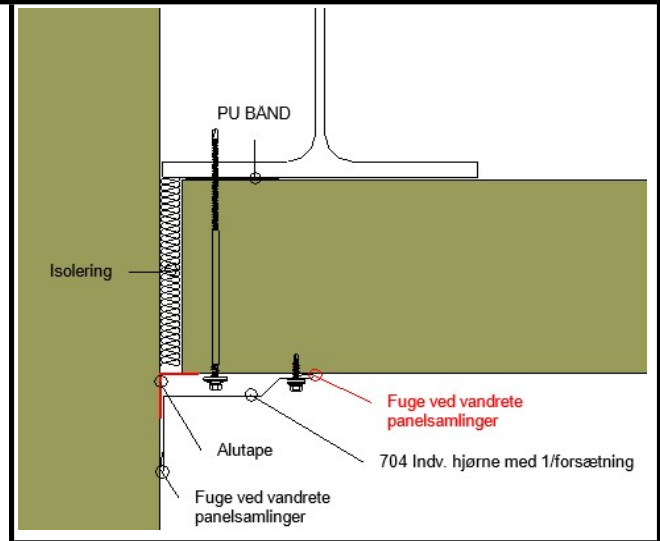

A: 120

Antal	Længde	Farve	Ståltykkelse	Info til kunde
			0,50	

705 - Indv. hjørne

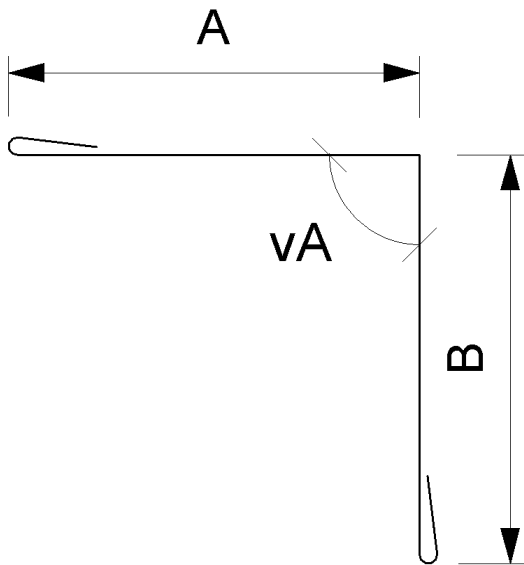
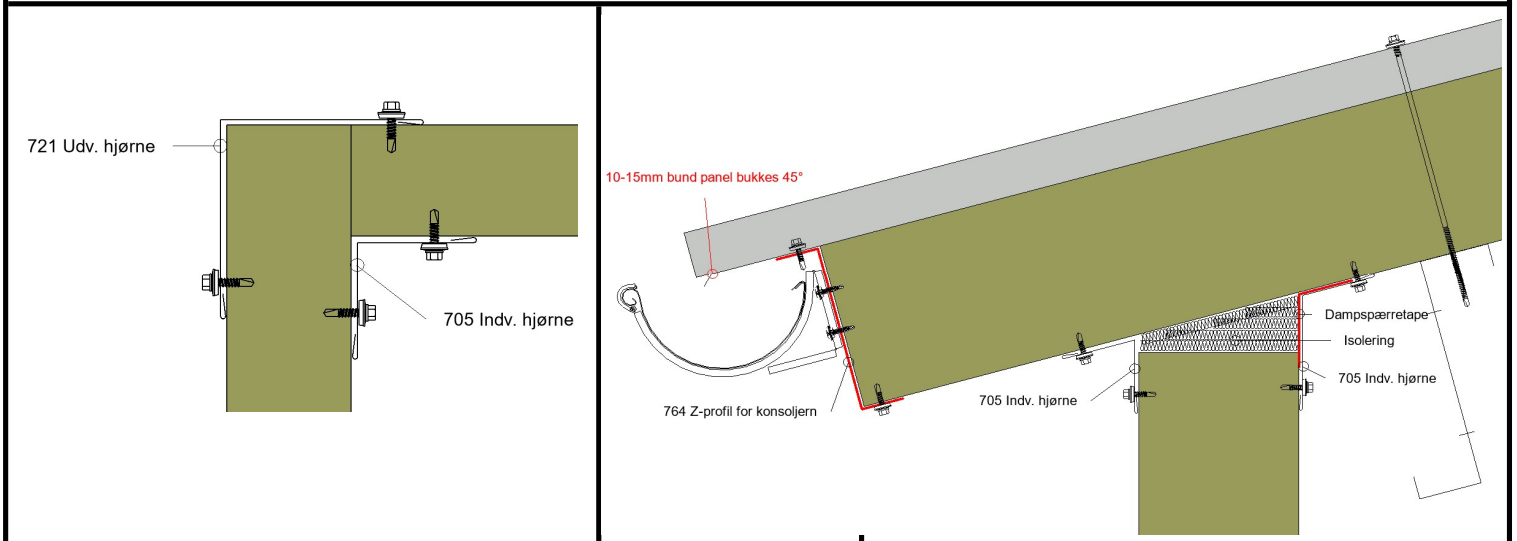

A: 70
 B: 70
 vA: 90°

(A & B = STD 70mm)

Antal	Længde	Farve	Ståltykkelse	Info til kunde
			0,50	

706 - Vandnæse ved sokkel (vandretliggende paneler)

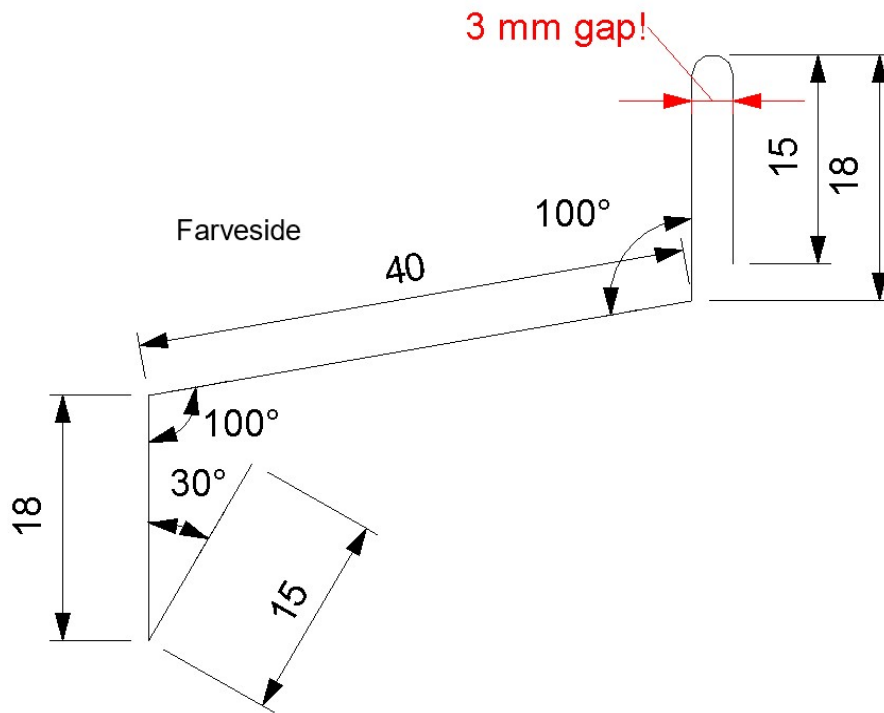
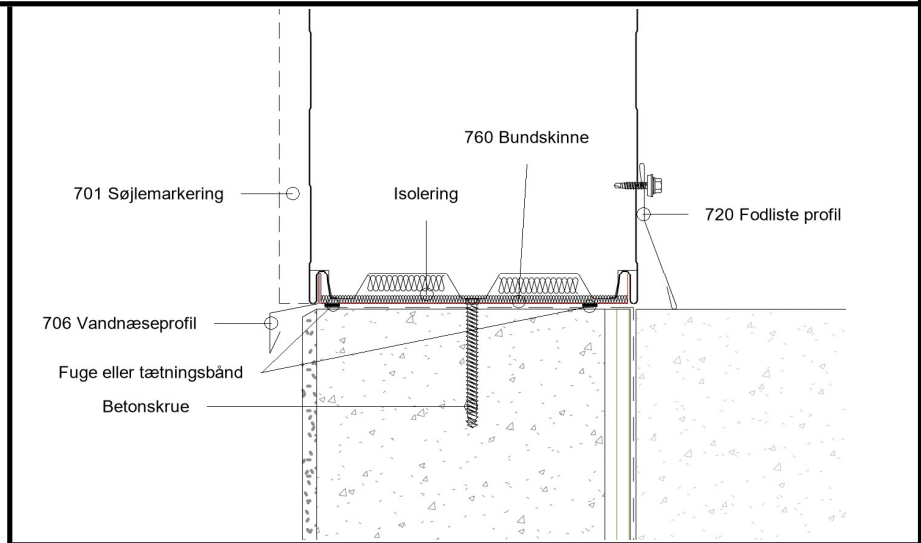

Antal	Længde	Farve	Ståltykkelse	Info til kunde
			0,50	

707 - Vandnæse ved sokkel (lodretstående paneler)

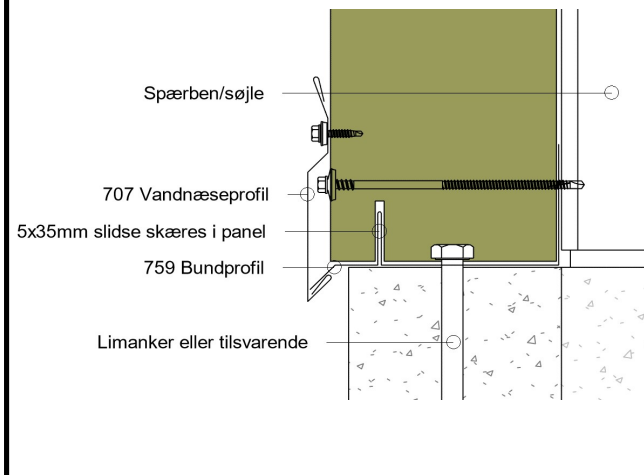
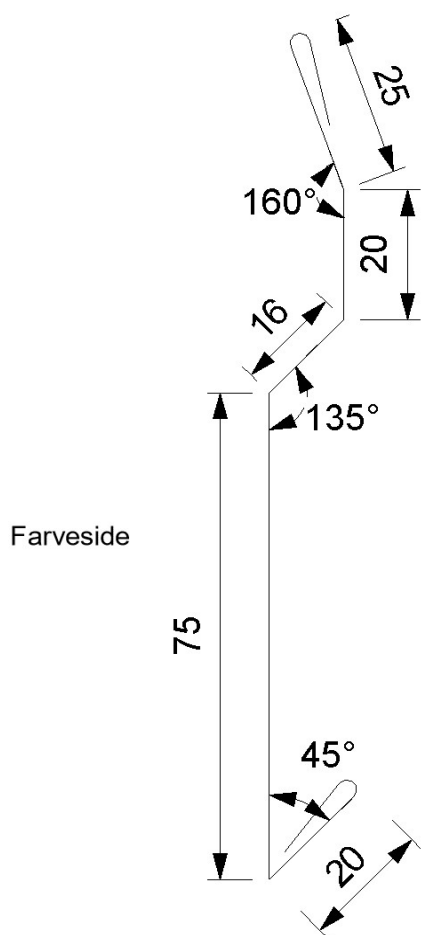

Antal	Længde	Farve	Ståltykkelse	Info til kunde
			0,50	

708 - løskant (til fugning mod mur)

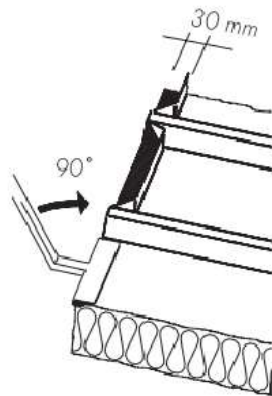

30mm bund af panel
bukkes 90° op!

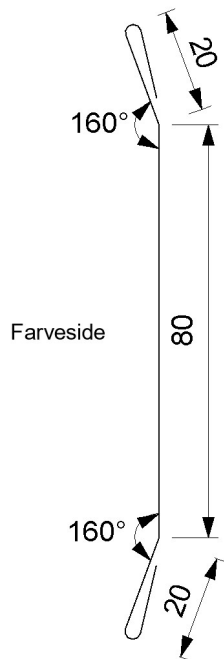
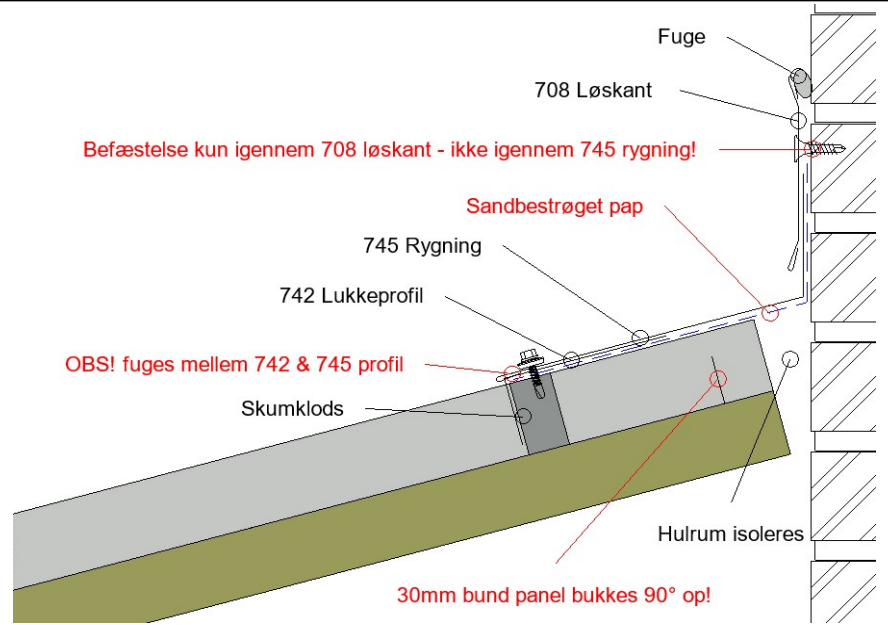

Antal	Længde	Farve	Ståltykkelse	Info til kunde
			0,50	

710 - Port top/sideinddækning

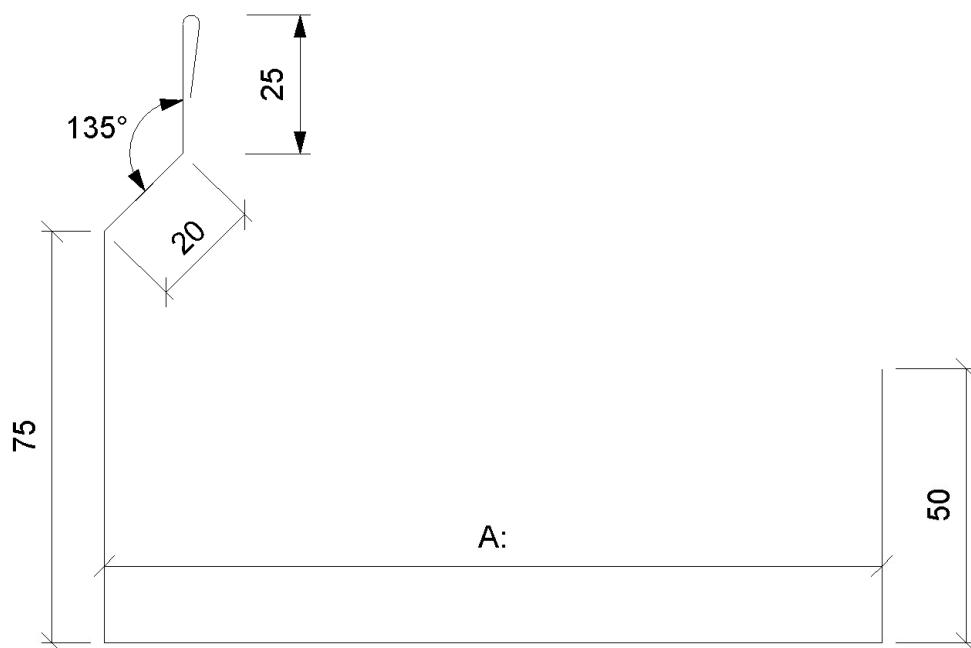
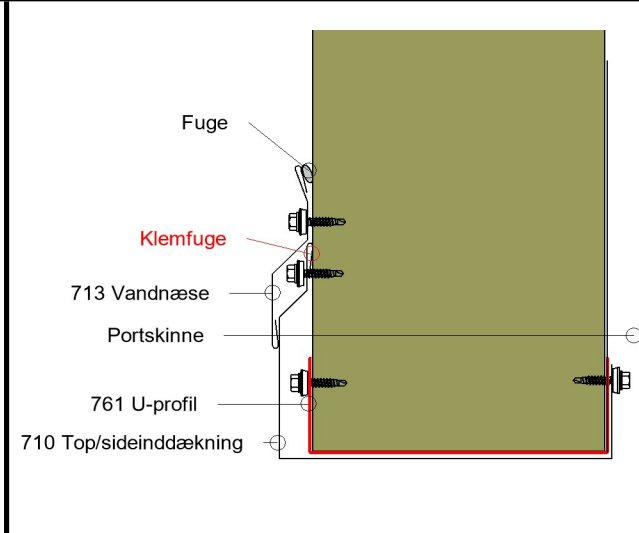

Farveside

A:

(A= paneltykkelse +16mm)

Antal	Længde	Farve	Ståltykkelse	Info til kunde
			0,50	

711 - Port top/sideinddækning (2-delt)

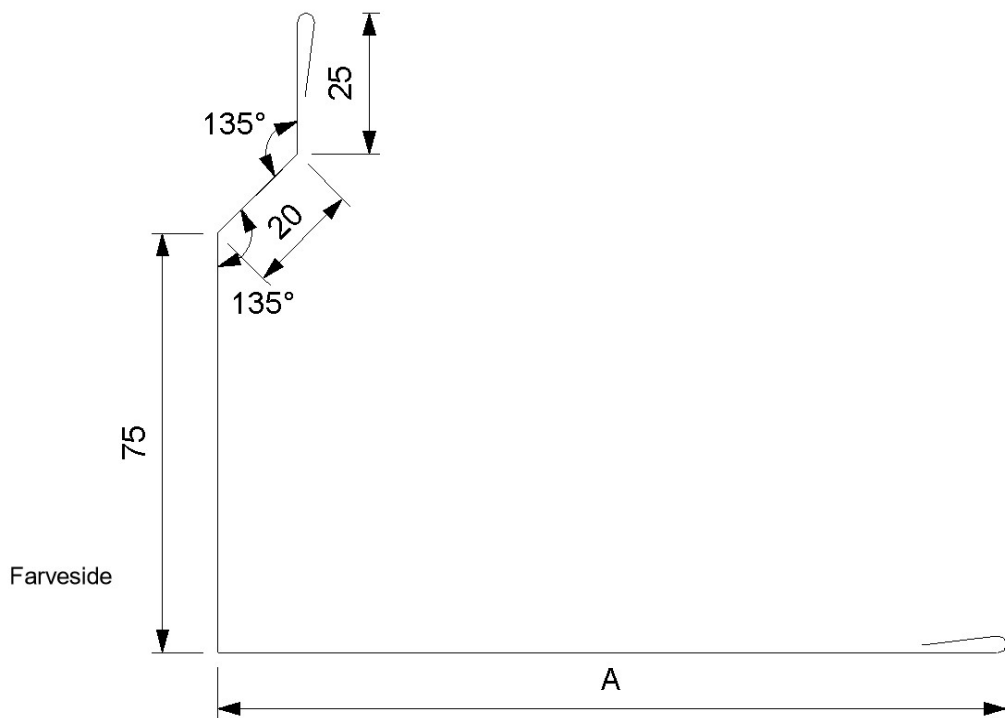
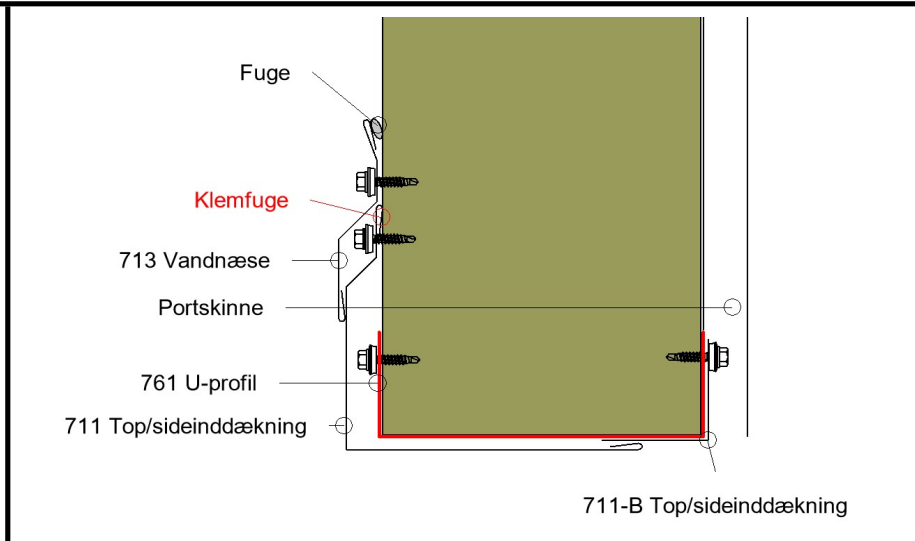

A:

Antal	Længde	Farve	Ståltykkelse	Info til kunde
			0,50	

711-B - Port top/sideinddækning (2-delt)

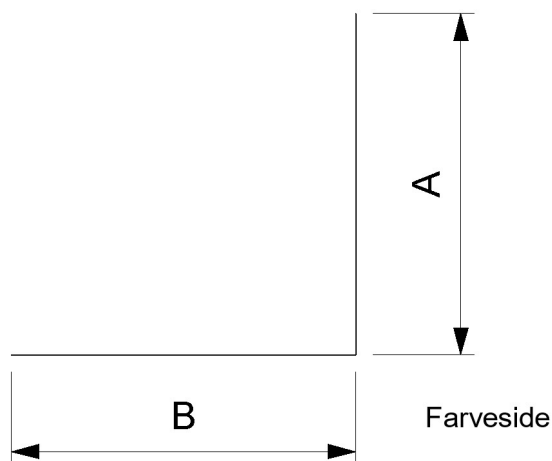
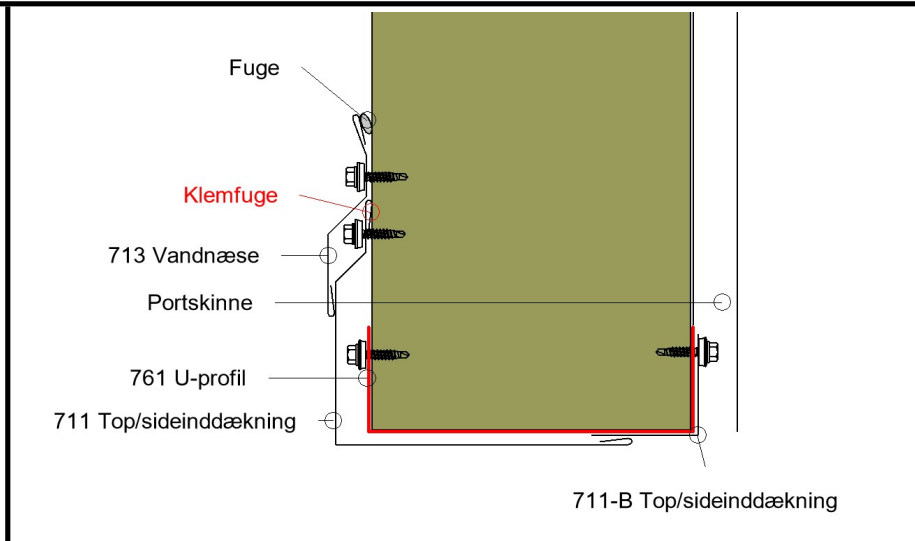

A:
B:

Antal	Længde	Farve	Ståltykkelse	Info til kunde
			0,50	

712 - Top/sideinddækning døre og vindue

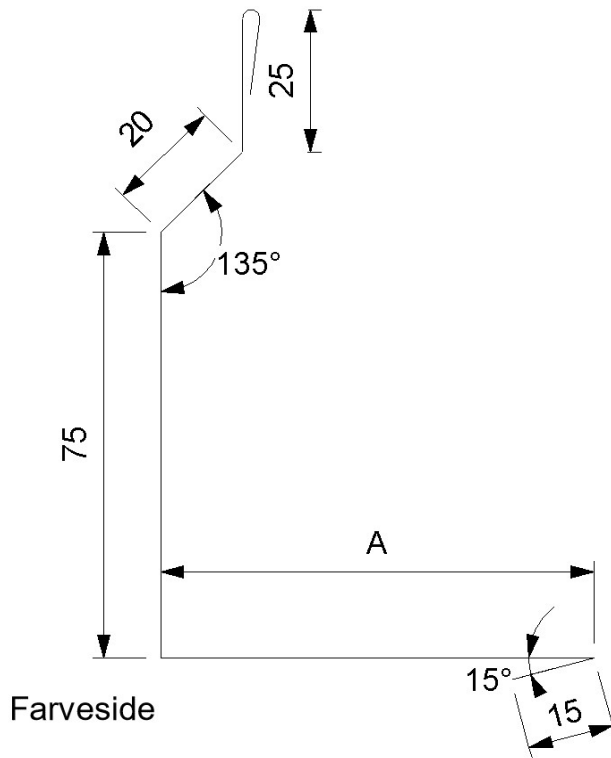
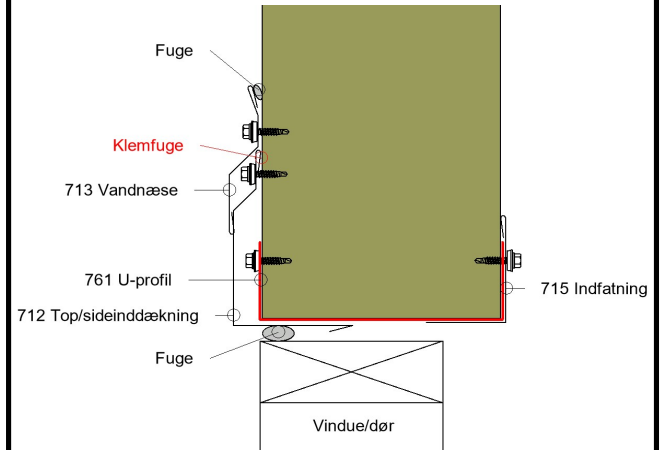

A: 50
(A= Std 50)

Antal	Længde	Farve	Ståltykkelse	Info til kunde
			0,50	

713 - Vandnæse over døre, vinduer og porte

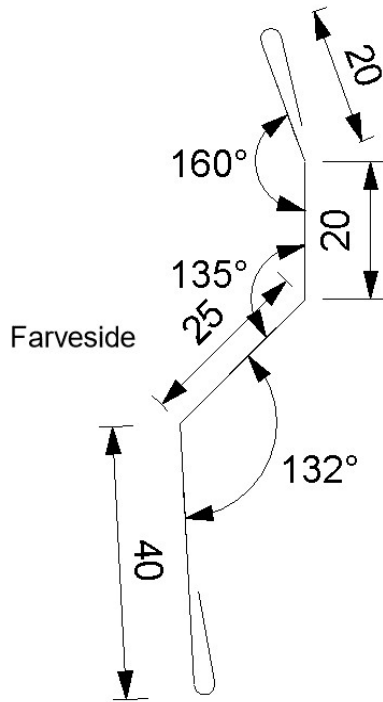
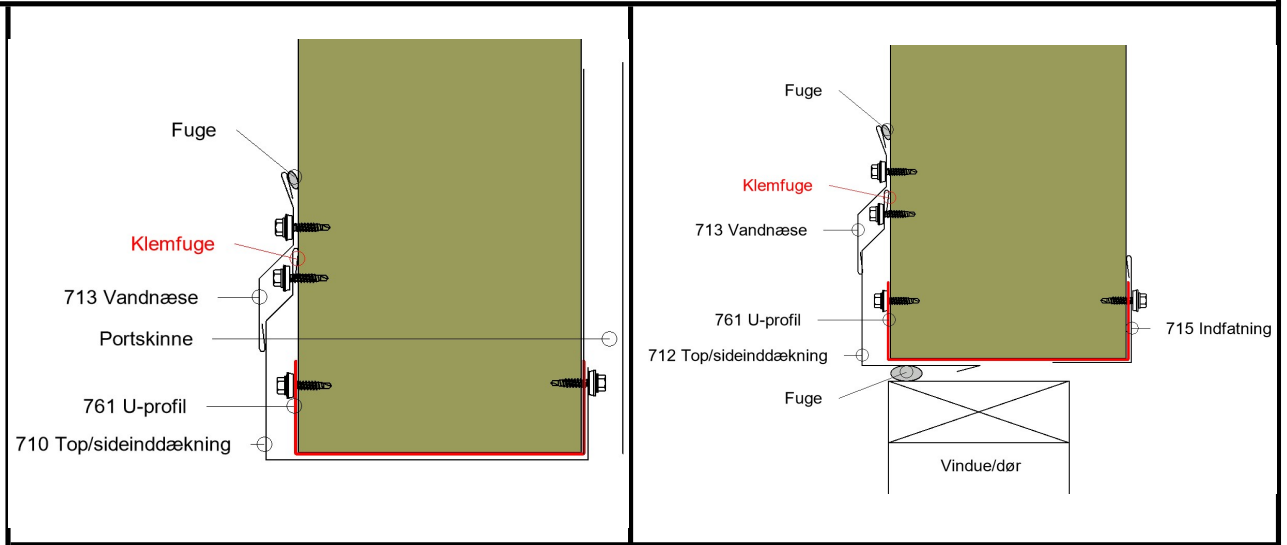

Antal	Længde	Farve	Ståltykkelse	Info til kunde
			0,50	

714 - Portinddækning indv. Vægge

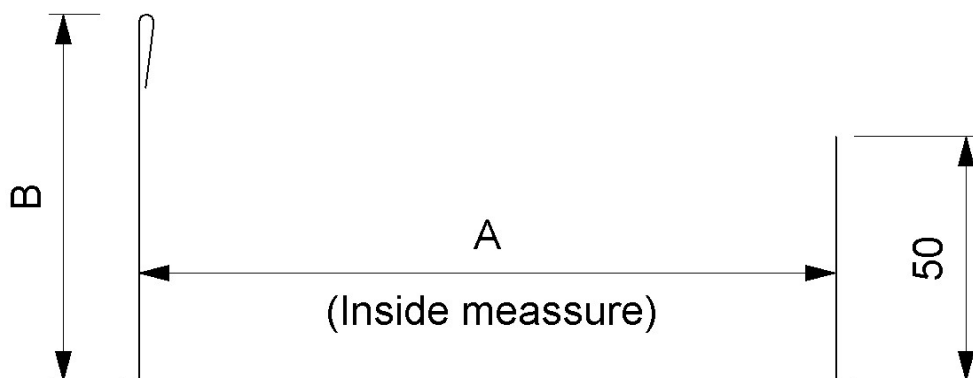
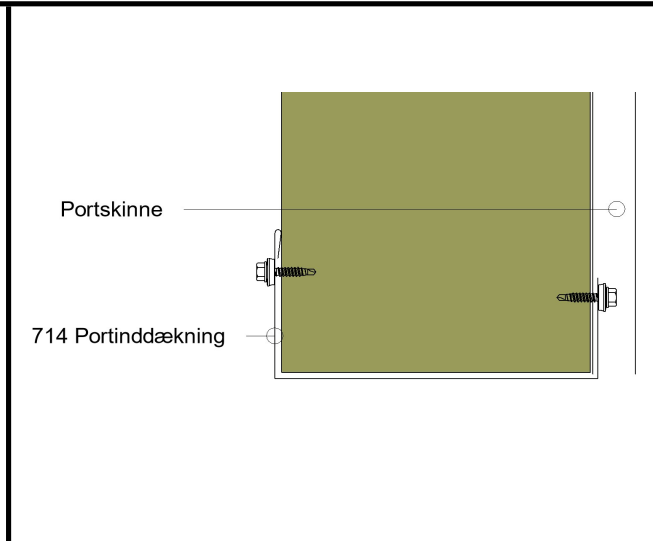

Farveside

A:
B: 70
(B= STD 70mm)

Antal	Længde	Farve	Ståltykkelse	Info til kunde
			0,50	

715 - Indfatning

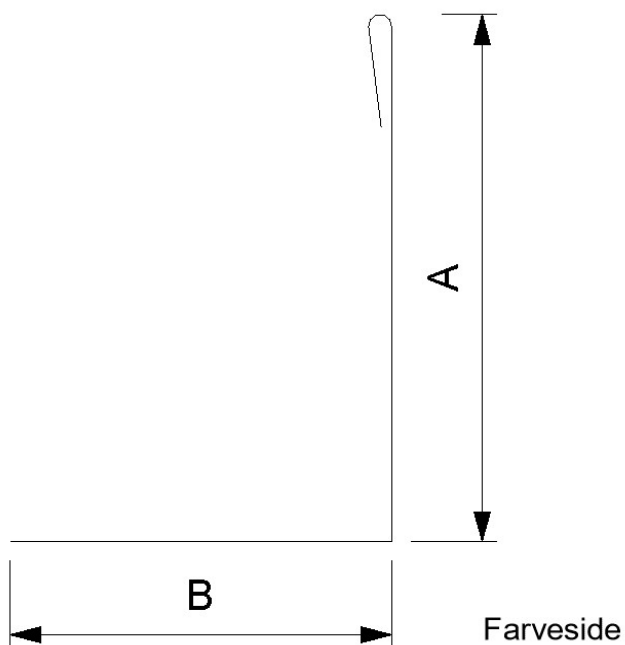
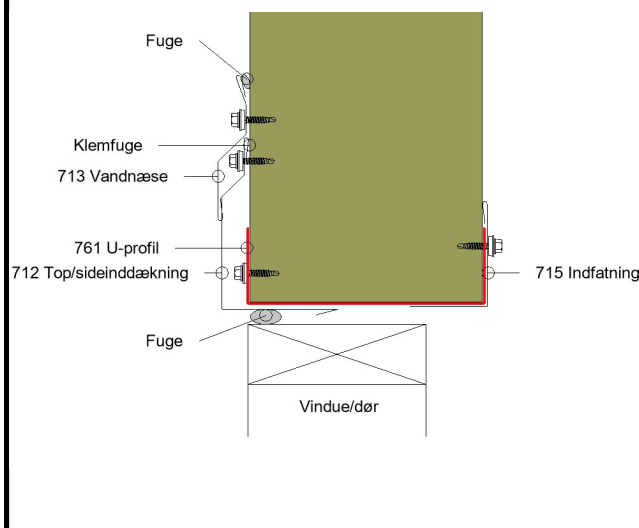

A: 70
 B:
 (A= Std 70)

Antal	Længde	Farve	Ståltykkelse	Info til kunde
			0,50	

716 - Side/topinddækning indiv. Vægge

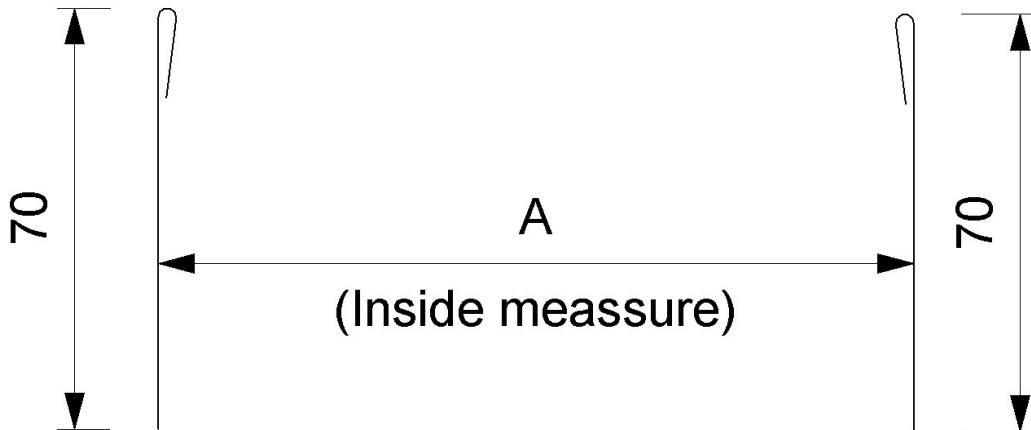
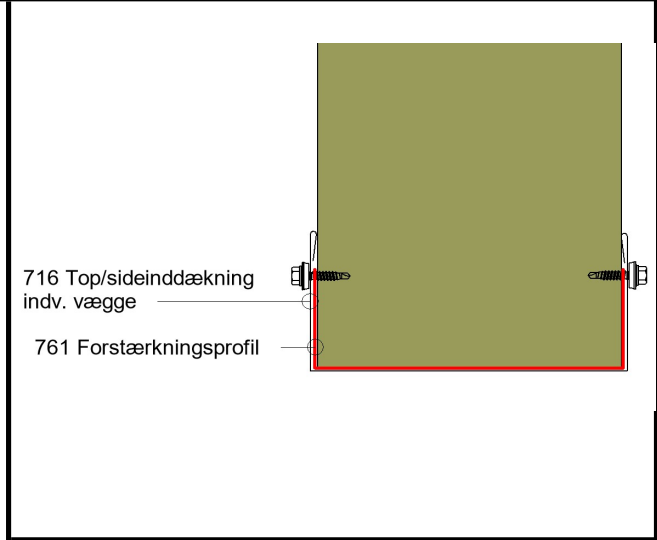

Farveside

A:
(A= paneltykkelse +2mm)

Antal	Længde	Farve	Ståltykkelse	Info til kunde
			0,50	

717 - Afslutningsprofil gavl/væg

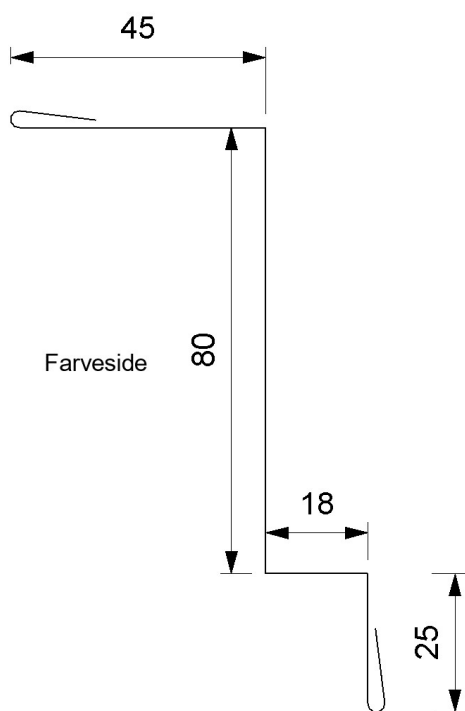
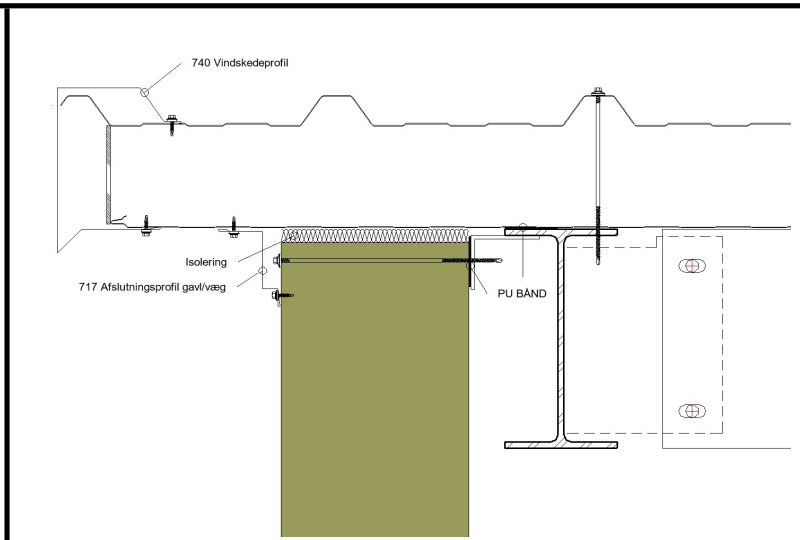

Antal	Længde	Farve	Ståltykkelse	Info til kunde
			0,50	

718 - Bundprofil indv lodretstående paneler

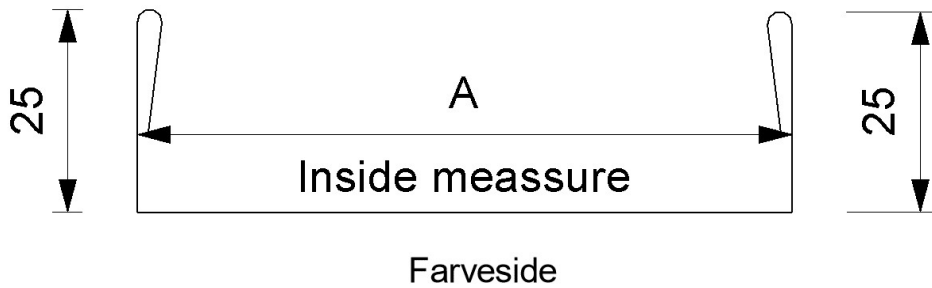
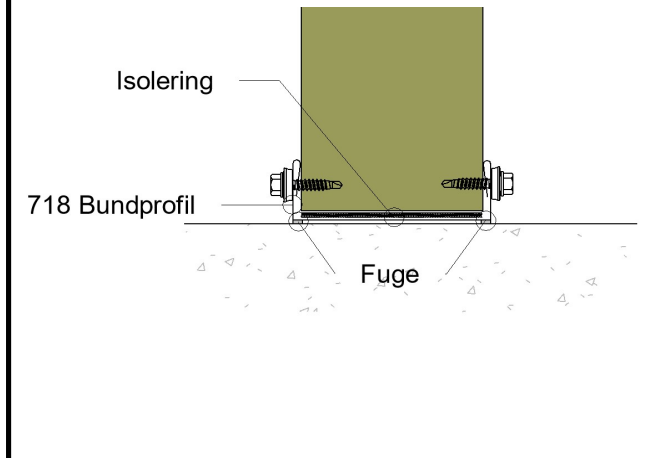

A:
(A=paneltykkelse +2mm)

Antal	Længde	Farve	Ståltykkelse	Info til kunde
			0,50	

720 - Fodliste

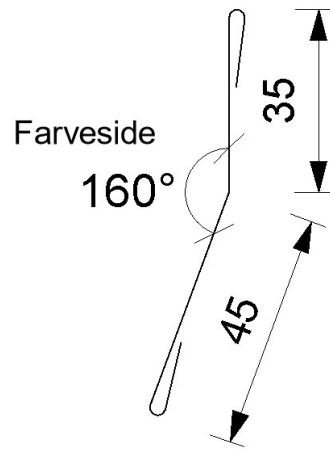
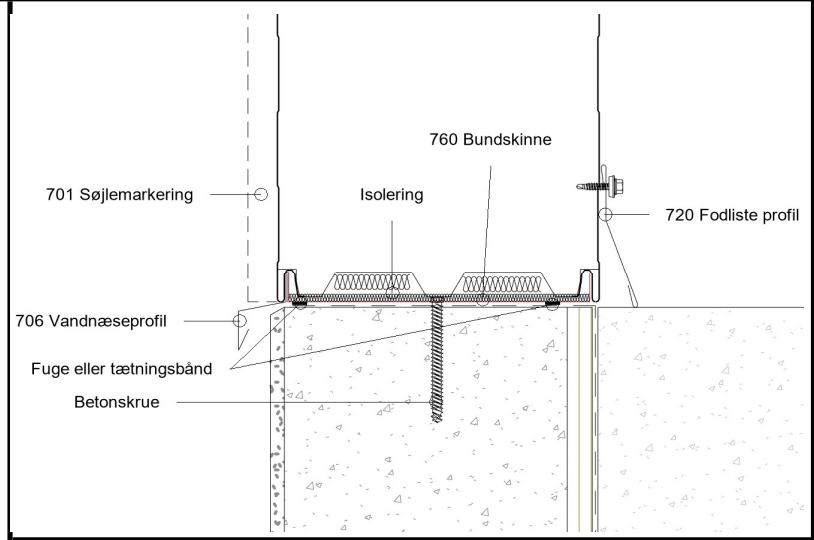

Antal	Længde	Farve	Ståltykkelse	Info til kunde
			0,50	

721 - Udv. Hjørne

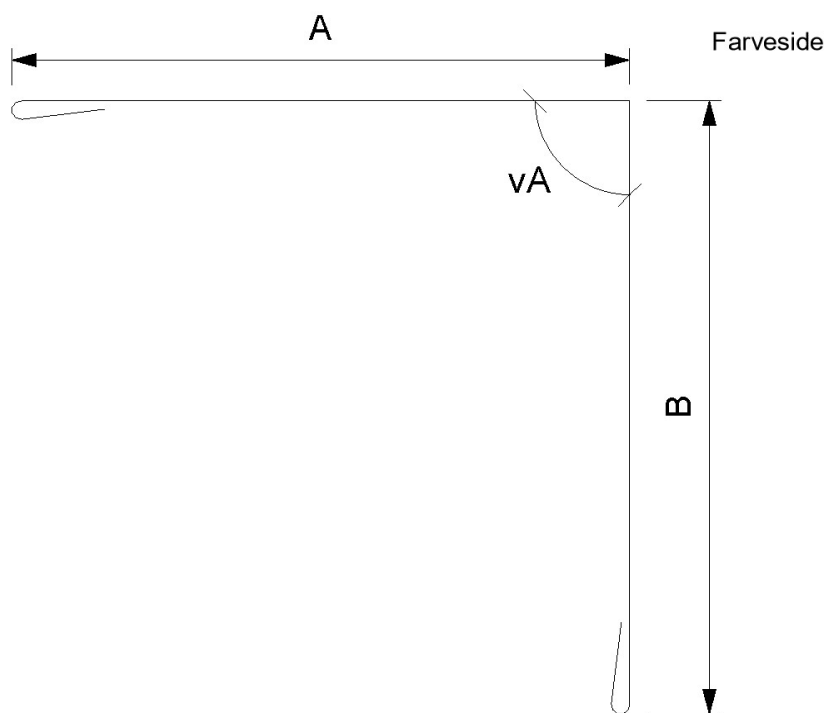
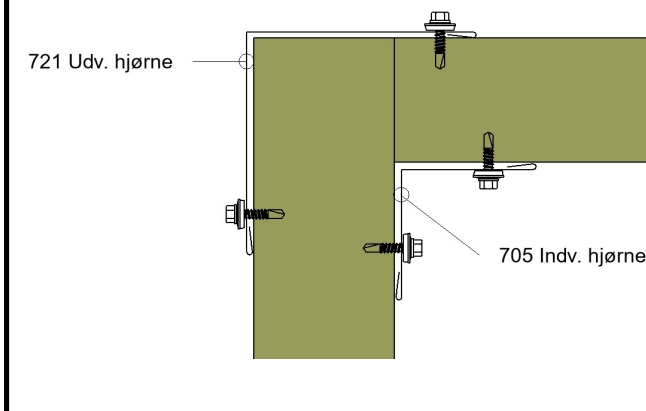

vA: °
 A:
 B:

Antal	Længde	Farve	Ståltykkelse	Info til kunde
			0,50	

722 - Indv. rygning

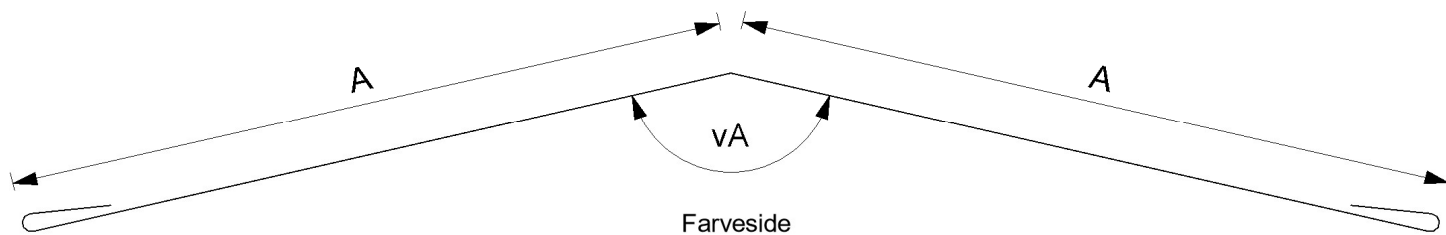
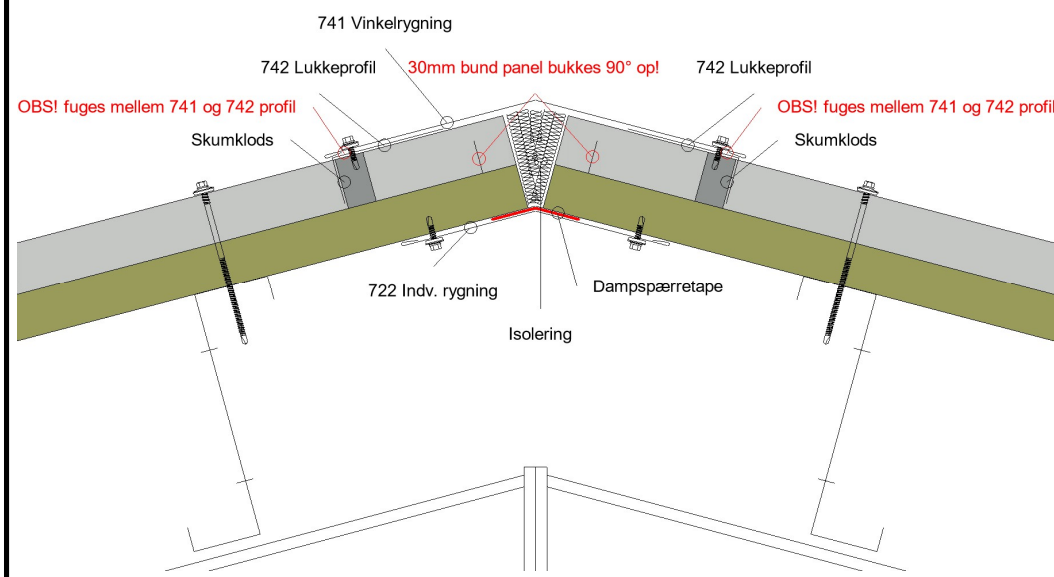

Taghældning i °	vA
5°	170°
10°	160°
15°	150°
20°	140°
25°	130°
30°	120°

vA: °
 A: 120
 (A= Std 120)

Antal	Længde	Farve	Ståltykkelse	Info til kunde
			0,50	

739 - Vindskede (uden udhæng)

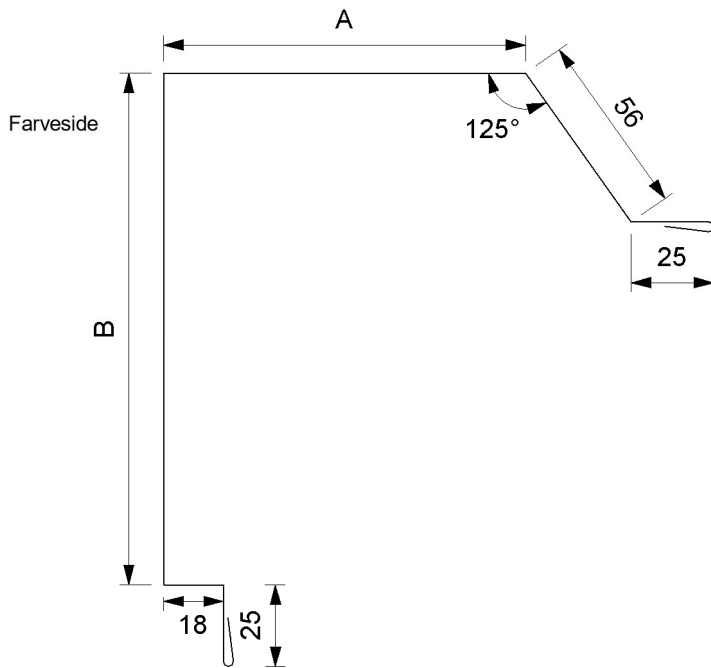
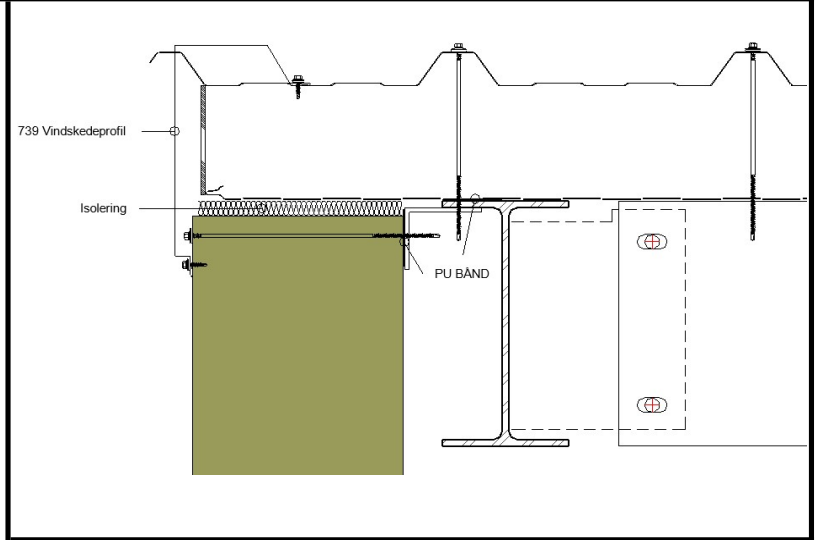

A: 110
B:

(B= Paneltykkelse inkl bølgetop + 60mm)

Antal	Længde	Farve	Ståltykkelse	Info til kunde
			0,50	

740 - Vindskede (med udhæng)

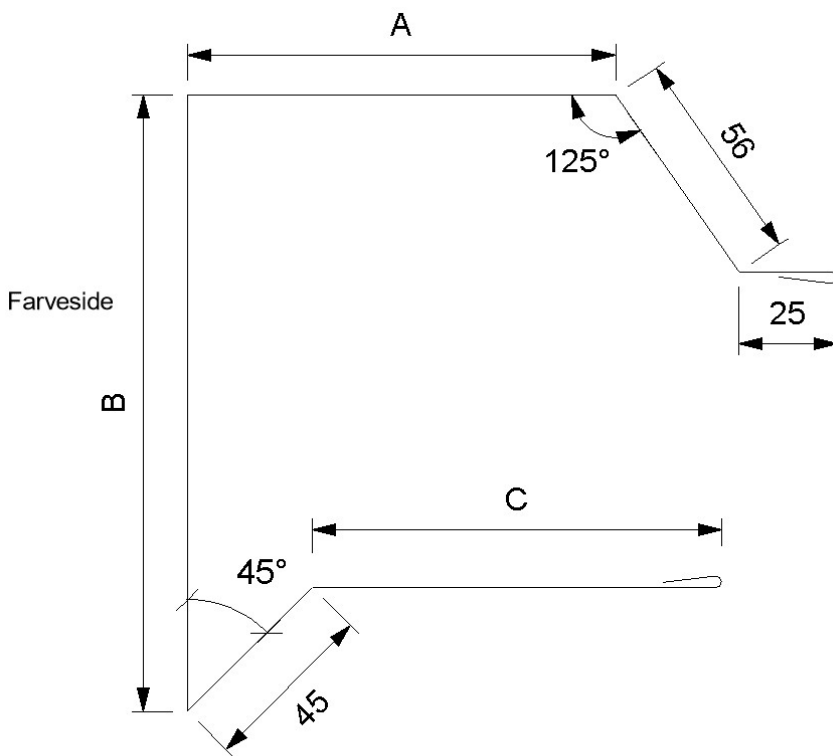
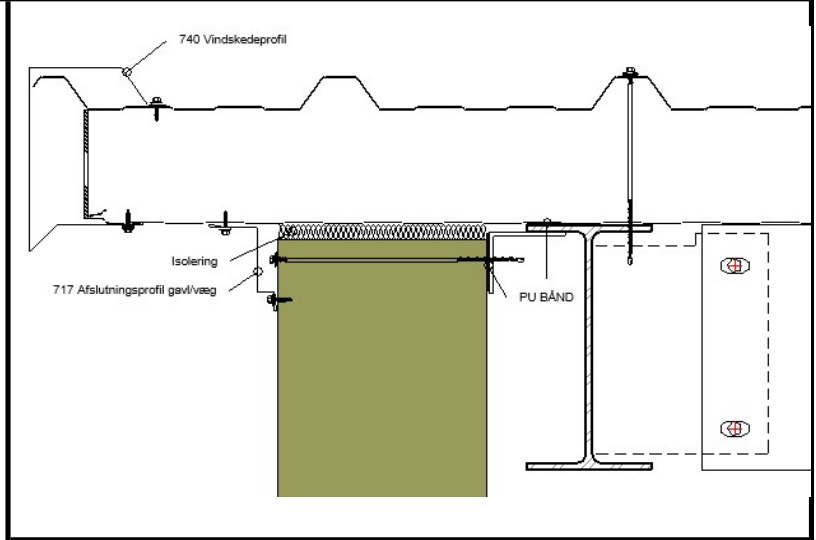

A: 110
 B:
 C: 100

(B= paneltykkelse + 80mm)

Antal	Længde	Farve	Ståltykkelse	Info til kunde
			0,50	

741 - Vinkelrygning

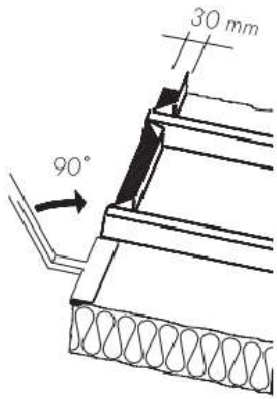

30mm bund af panel bukkes 90° op!

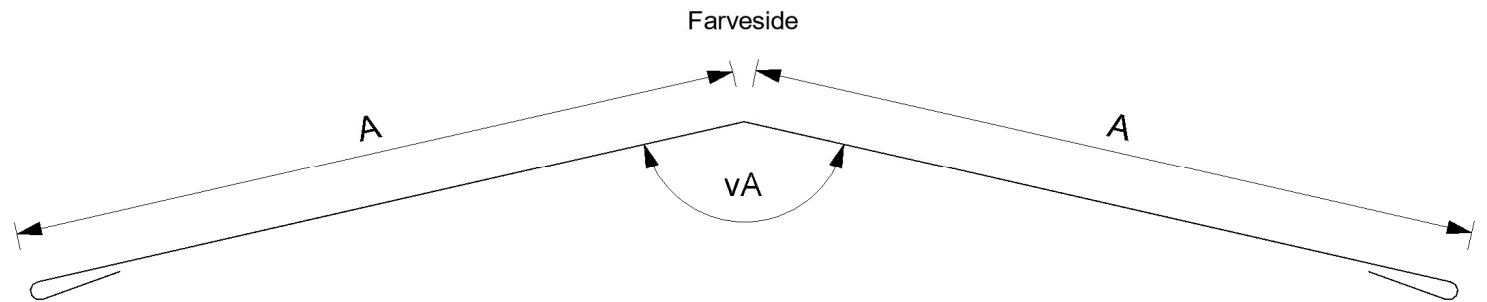
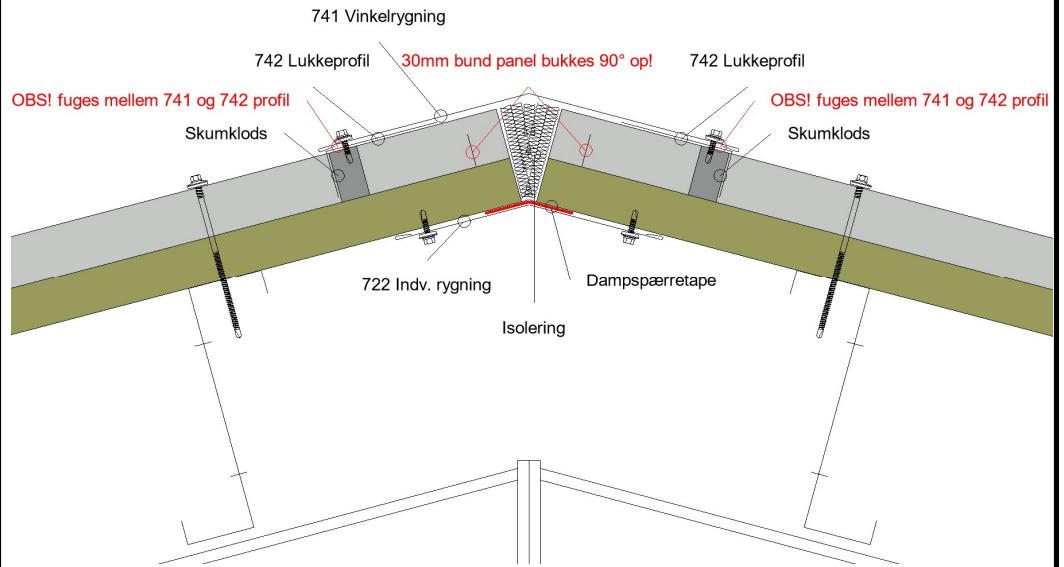

Tøghældning i °	vA
5°	170°
10°	160°
15°	150°
20°	140°
25°	130°
30°	120°

vA: °
A:

Antal	Længde	Farve	Ståltykkelse	Info til kunde
			0,50	

742-B Lukkeprofil til rygning ovenlysprofil

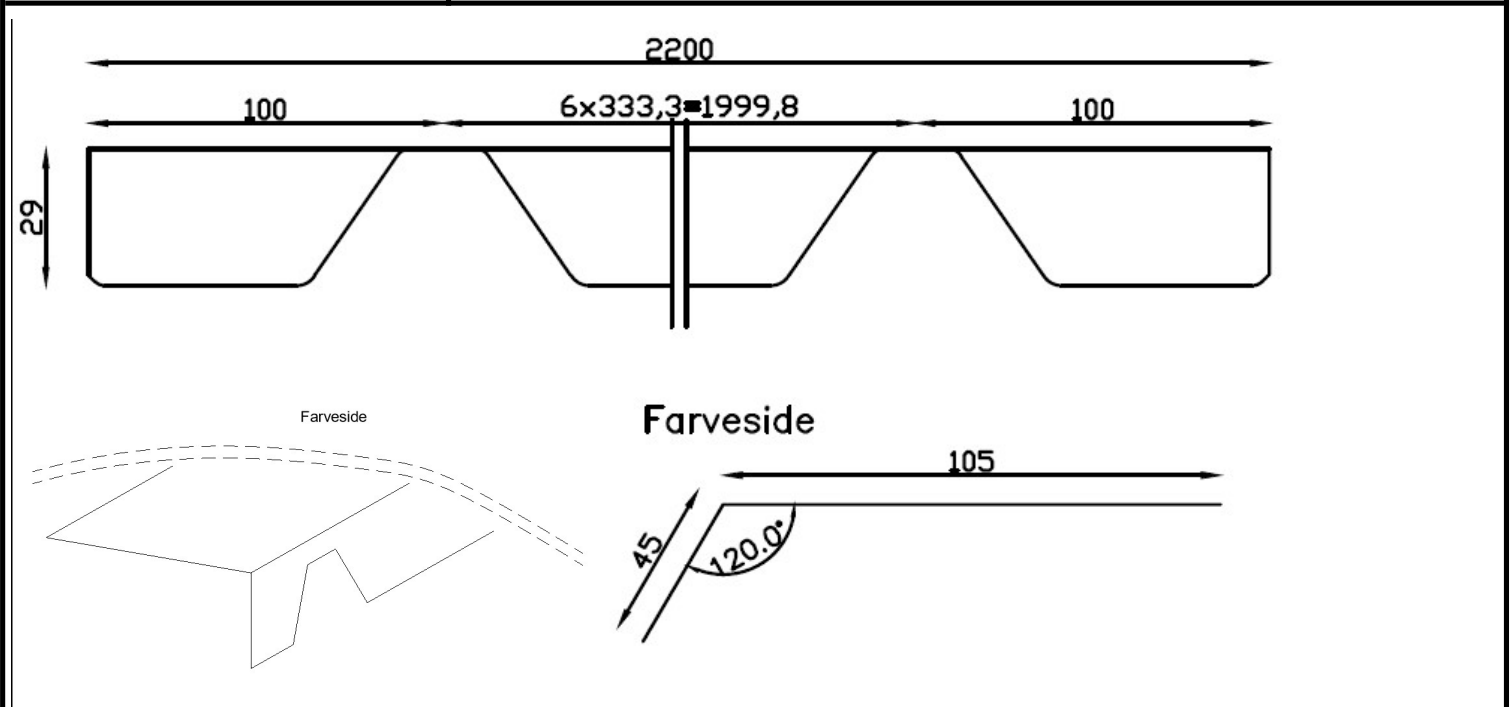
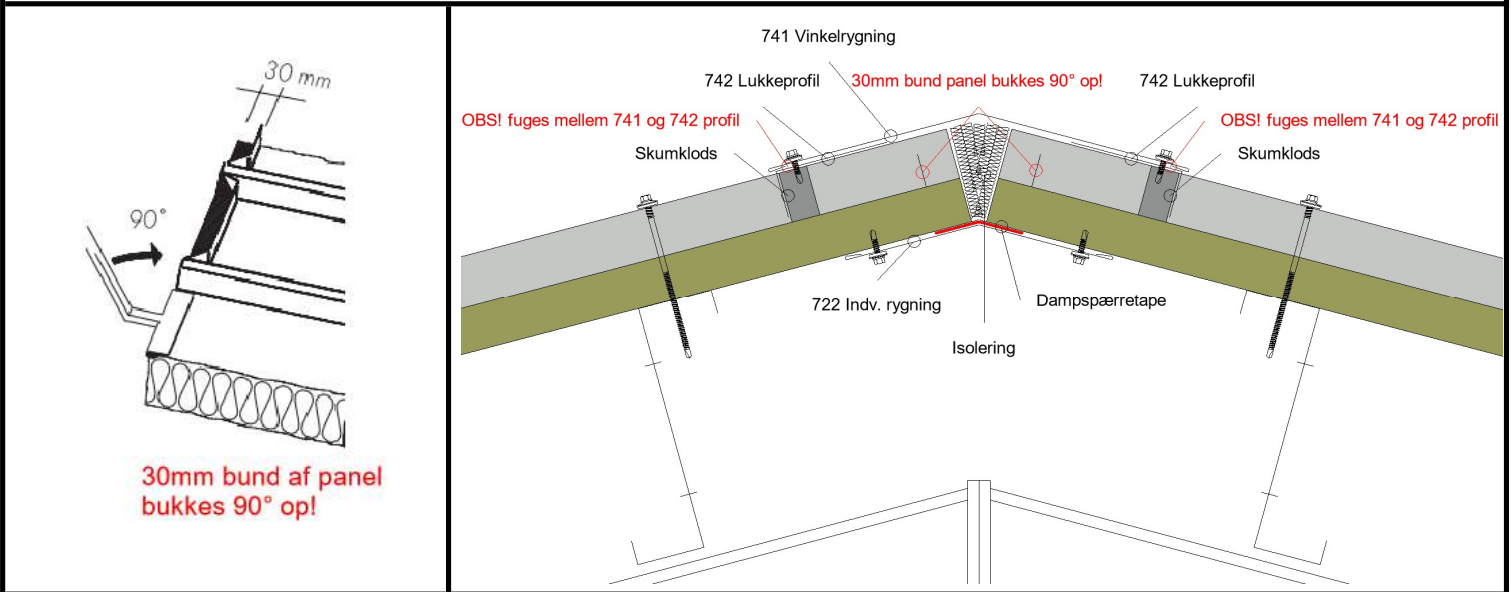

Antal	Længde	Farve	Ståltykkelse	Info til kunde
	2200		0,50	

742-P (OBR_PD4) Lukkeprofil til rygning ovenlysprofil

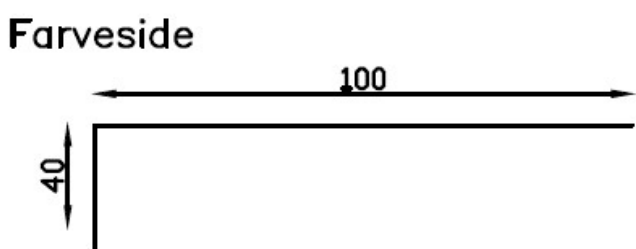
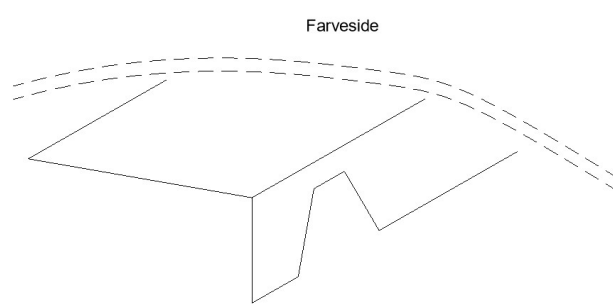
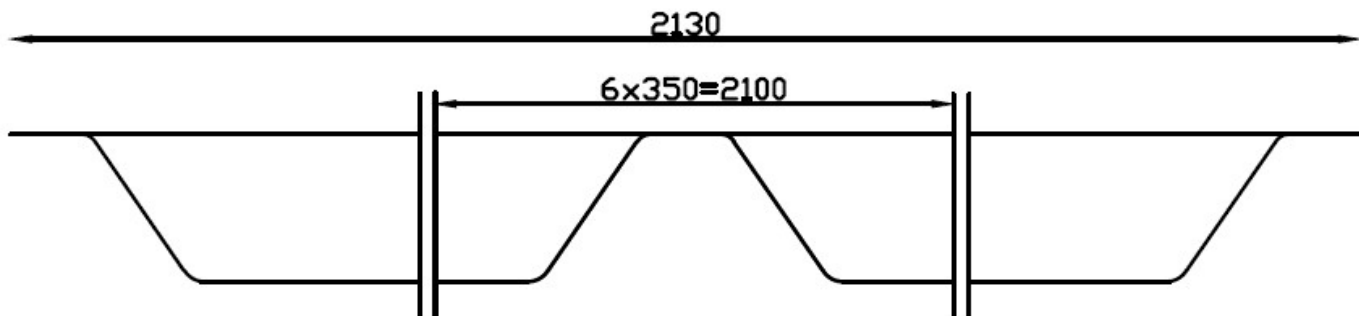
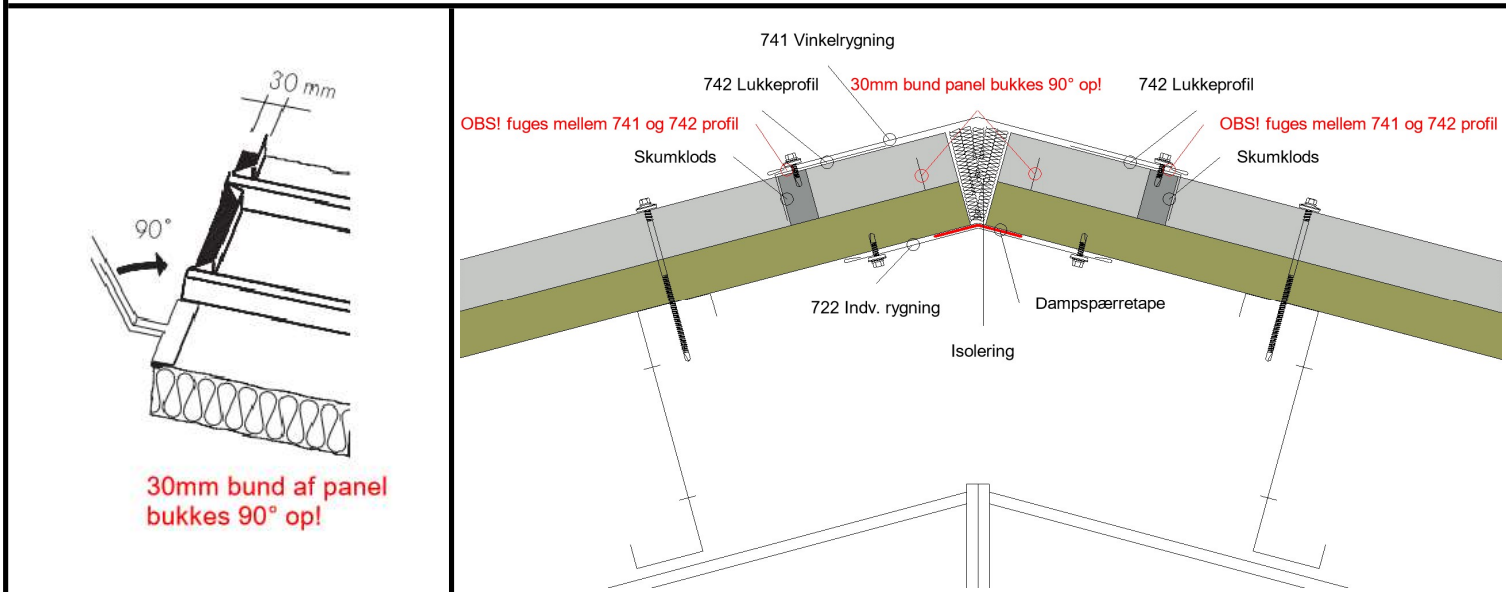

Antal	Længde	Farve	Ståltykkelse	Info til kunde
	2130		0,50	

742-T Lukkeprofil til rygning ovenlysprofil

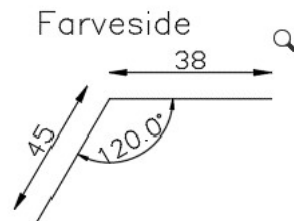
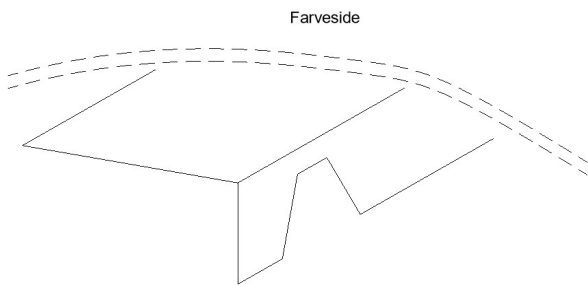
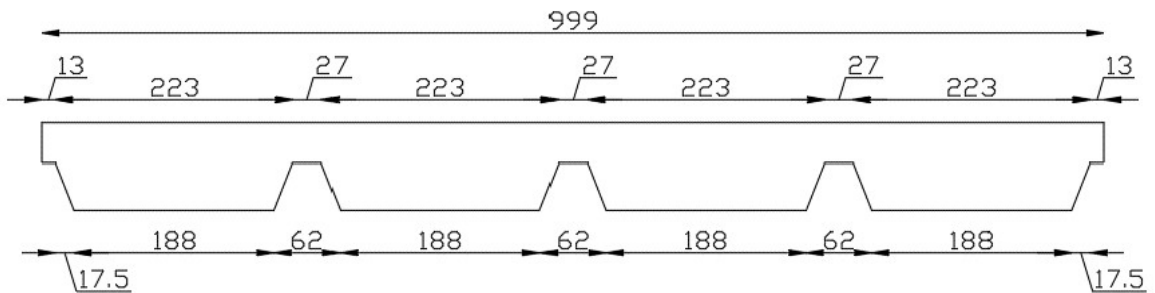
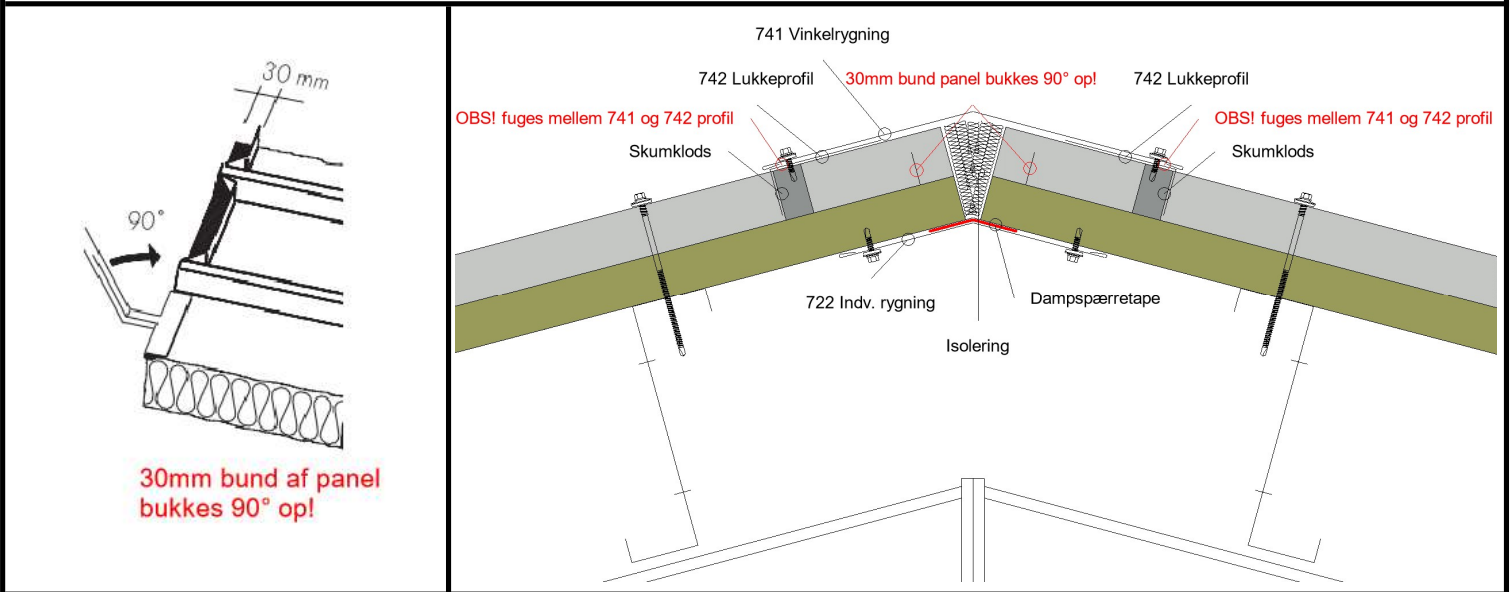

Antal	Længde	Farve	Ståltykkelse	Info til kunde
	999		0,50	

743 - Pultrygning

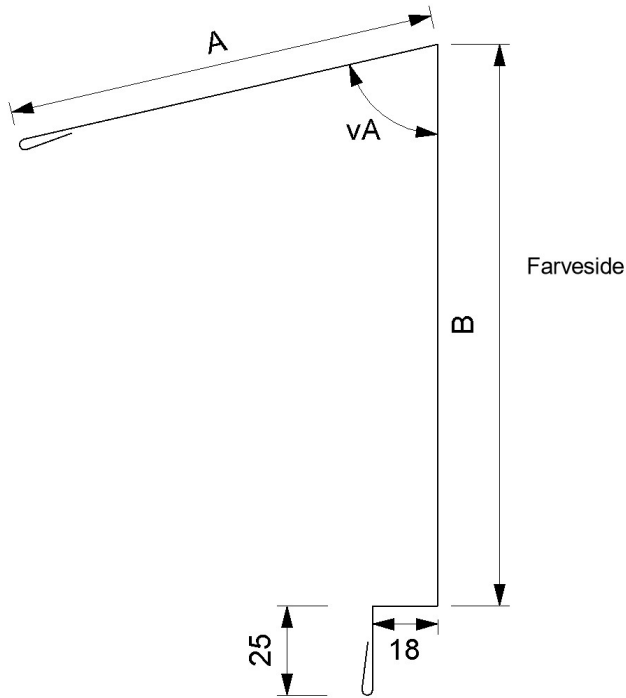
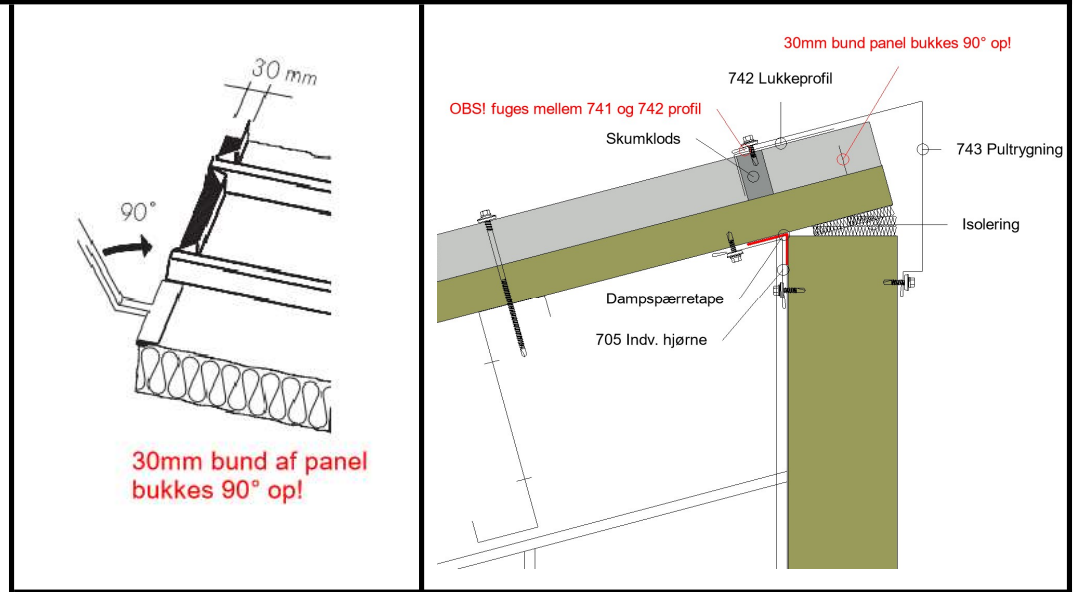

vA: °
 A: 190
 B:

(A = STD 190mm)

Antal	Længde	Farve	Ståltykkelse	Info til kunde
			0,50	

744 - Murkrone/løskant

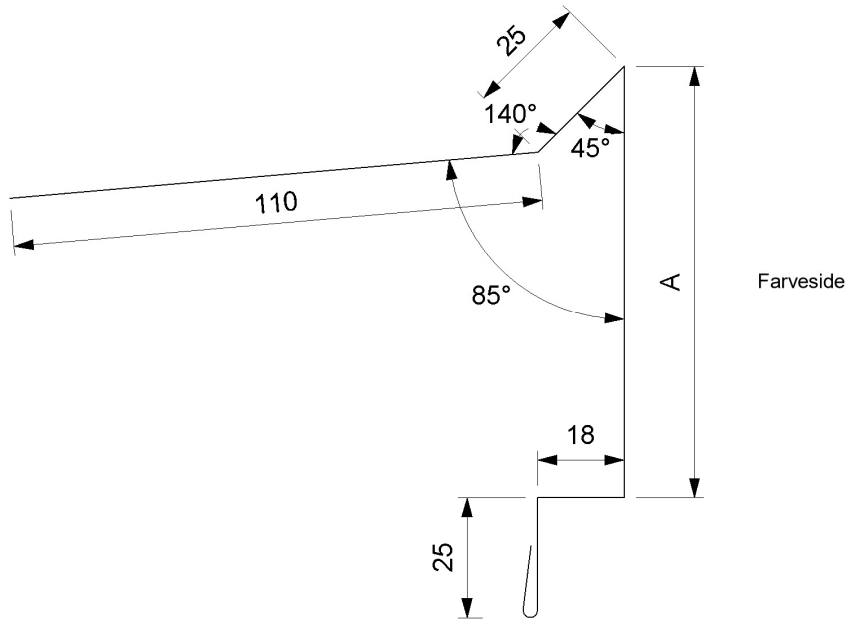
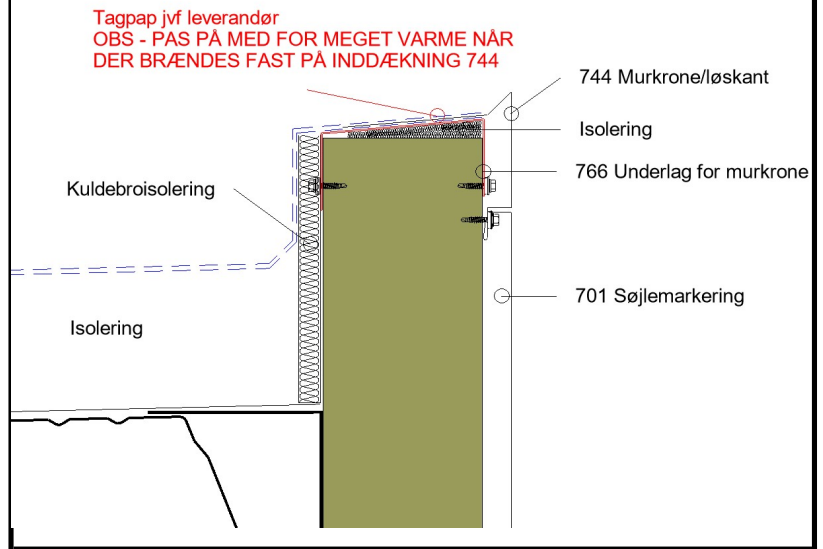

A: 100

Antal	Længde	Farve	Ståltykkelse	Info til kunde
			0,50	

744-B Murkroneinddækning

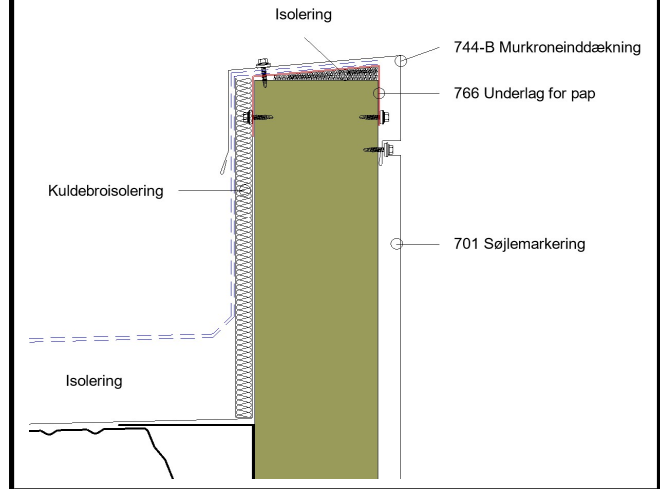

Farveside

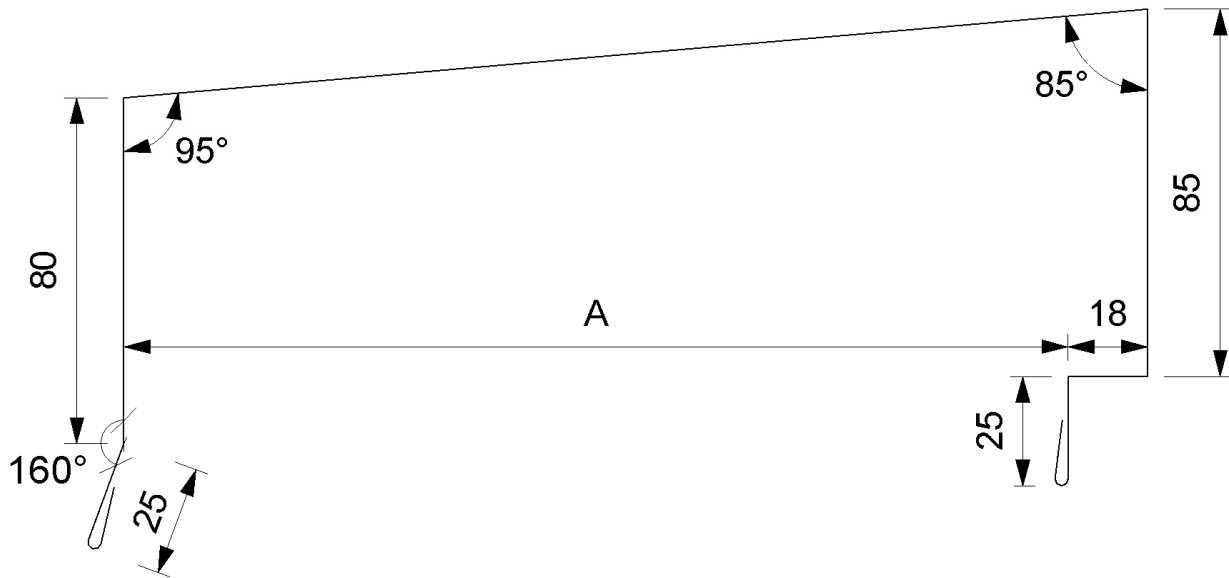

A:

Antal	Længde	Farve	Ståltykkelse	Info til kunde
			0,50	

745 - Ovenlysinddækning / Rygning imod højere bygning

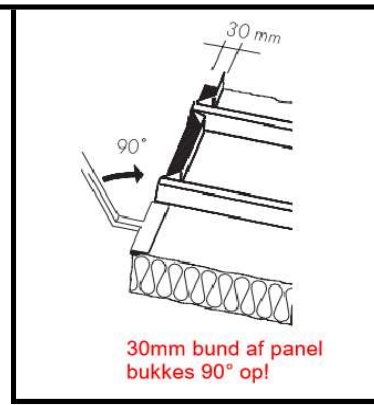
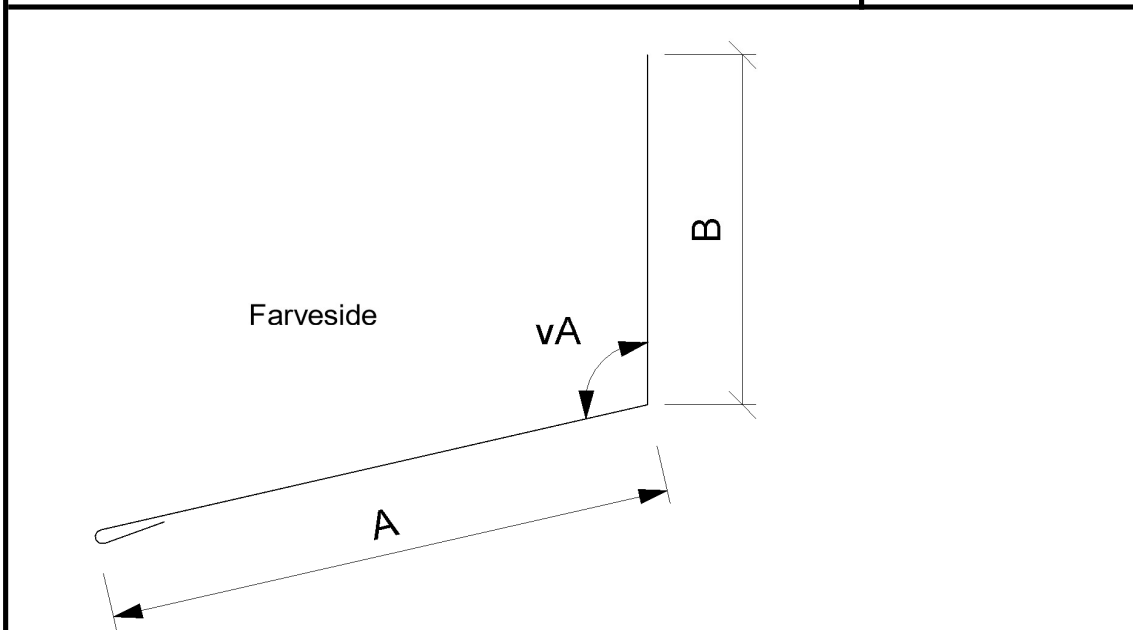
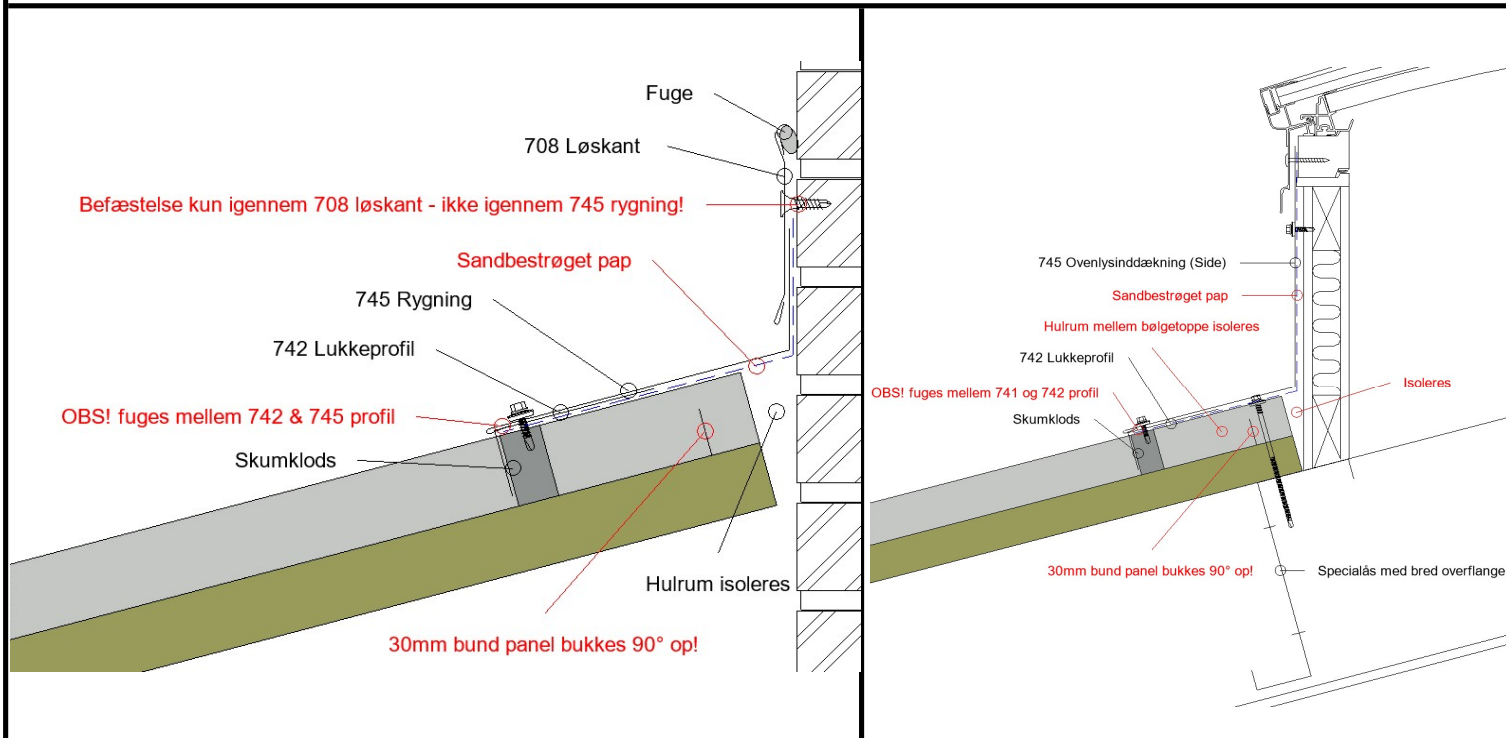

30mm bund af panel bukket 90° op!

vA: °
 A: 190
 B:

(B = Std 190mm)

Antal	Længde	Farve	Ståltykkelse	Info til kunde
			0,50	

746 - Ovenlysinddækning (Gavl)

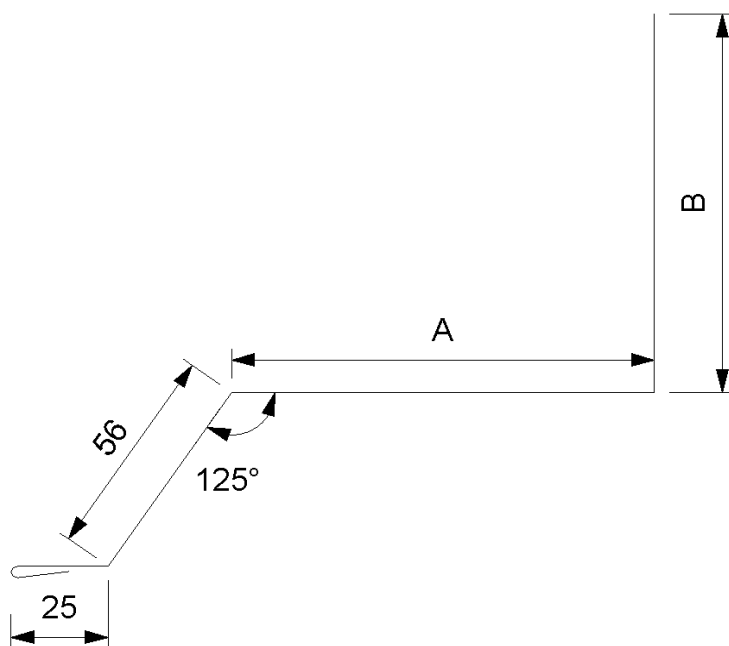
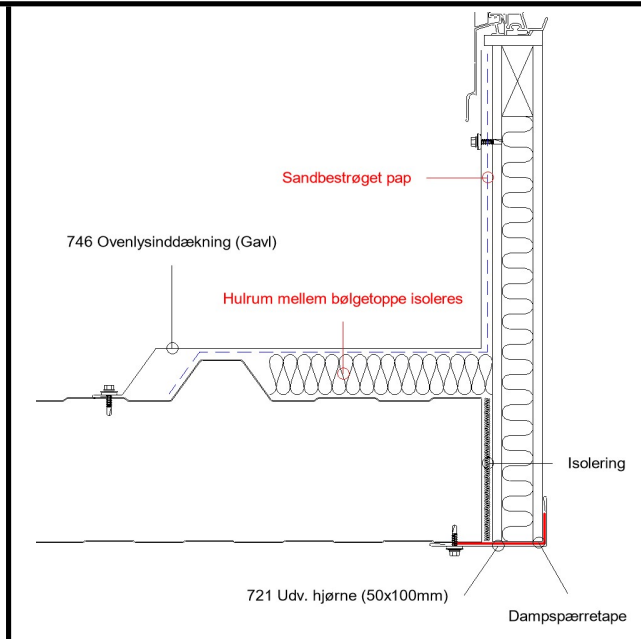

A:
B:

Antal	Længde	Farve	Ståltykkelse	Info til kunde
			0,50	

747 - Planplade til tagfod uden udhæng og ovenlys

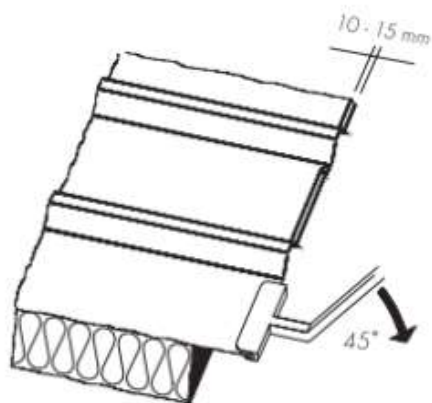

10-15mm bund af panel bukkes for at modvirke tagdryp render op ad!

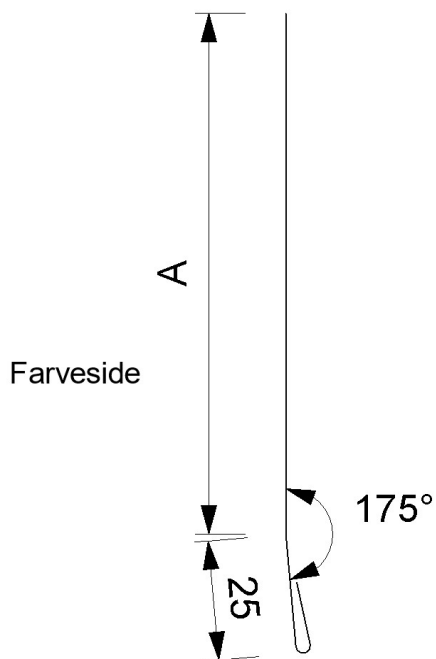
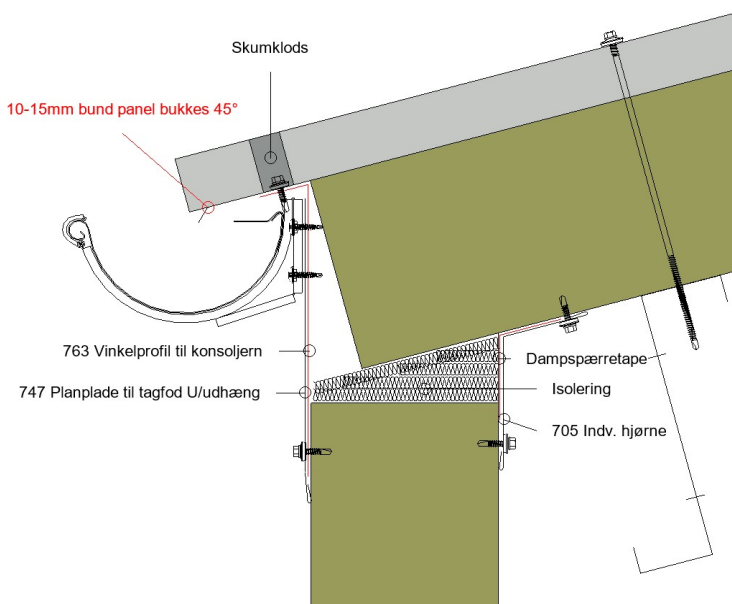

A:

Antal	Længde	Farve	Ståltykkelse	Info til kunde
			0,50	

749 - Rosette / Planplade

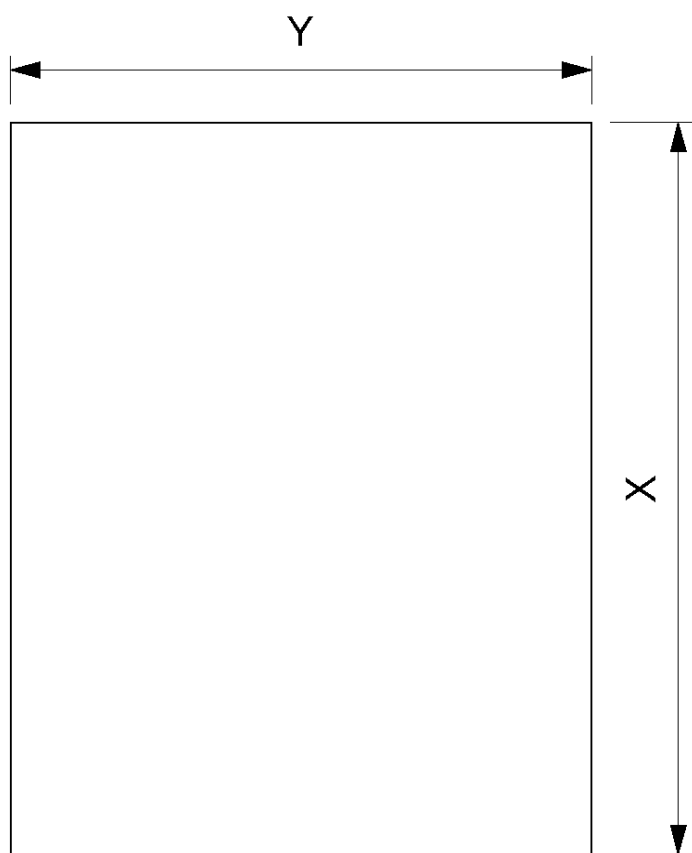

X: 400
Y: 300

Antal		Farve	Ståltykkelse	Info til kunde
			0,50	

Special inddækning type:



--	--

Antal	Længde	Farve	Ståltykkelse	Info til kunde
			0,50	

759 - Bundskinne (Lodretstående paneler)

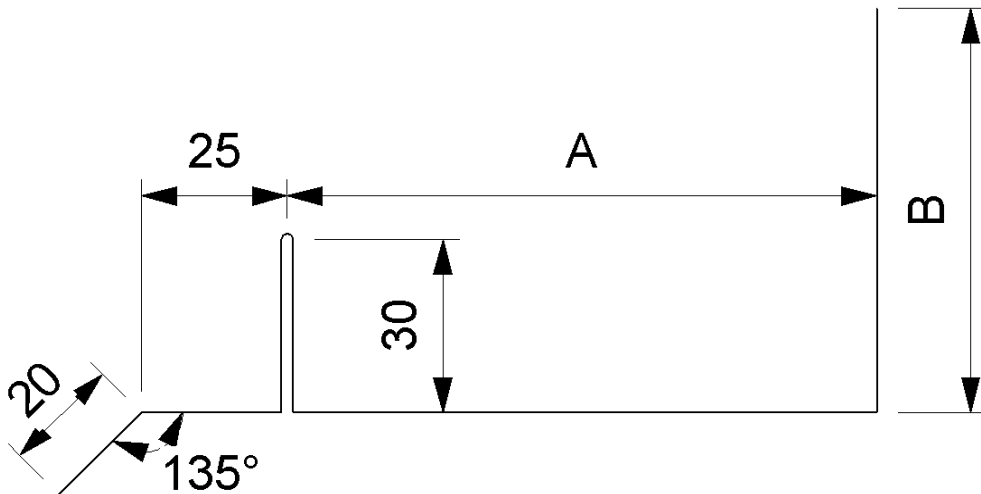
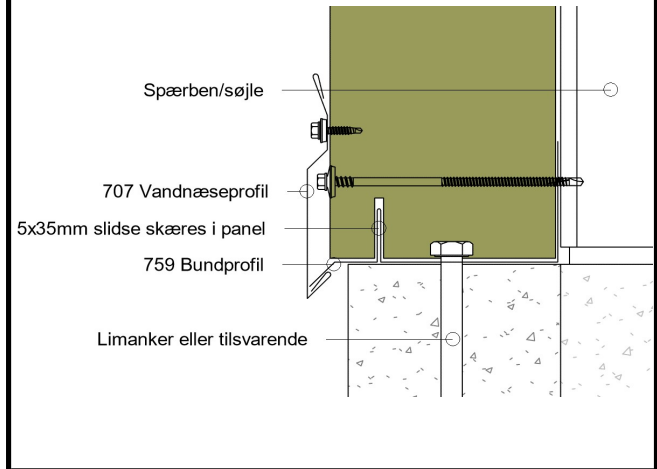

A:
B: 60
(A = Paneltykkelse - 30mm)

Antal	Længde	Farve	Ståltykkelse	Info til kunde
		Galv	1,50	

760 - Bundskinne (vandretliggende paneler)

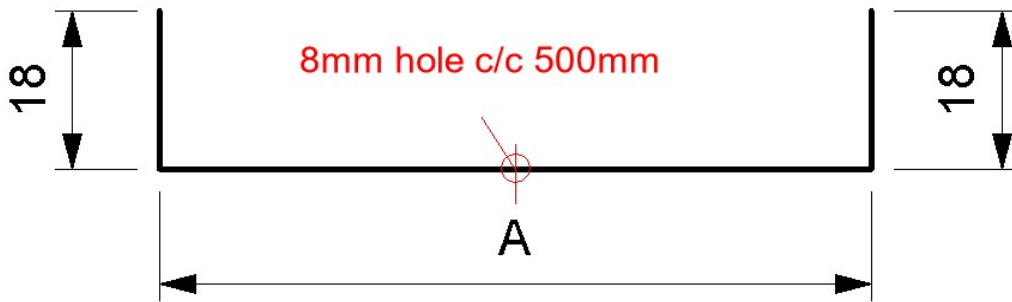
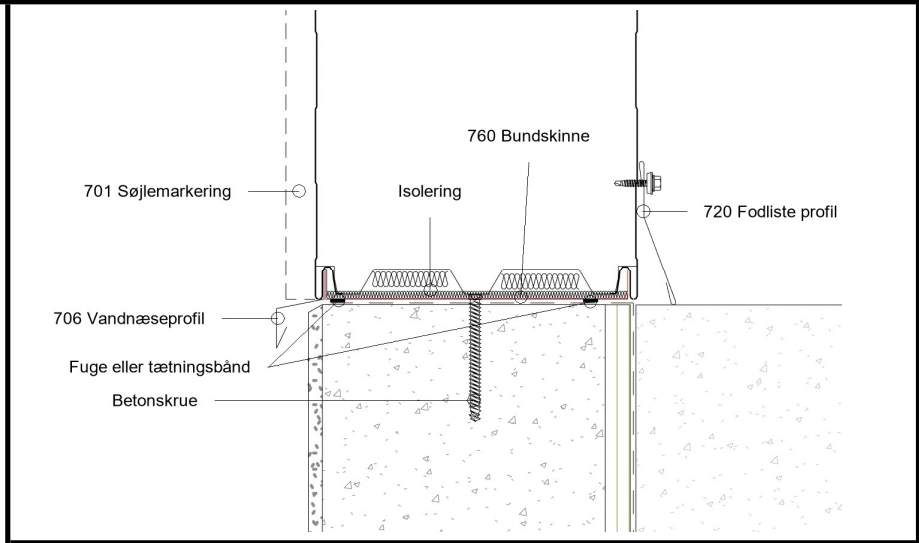

A:

Antal	Længde	Farve	Ståltykkelse	Info til kunde
		Galv	1,50	

761 - U-profil (Forstærkning vindue, døre og porthul)

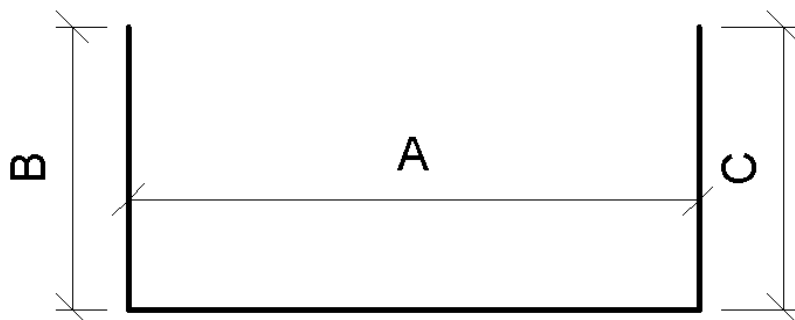
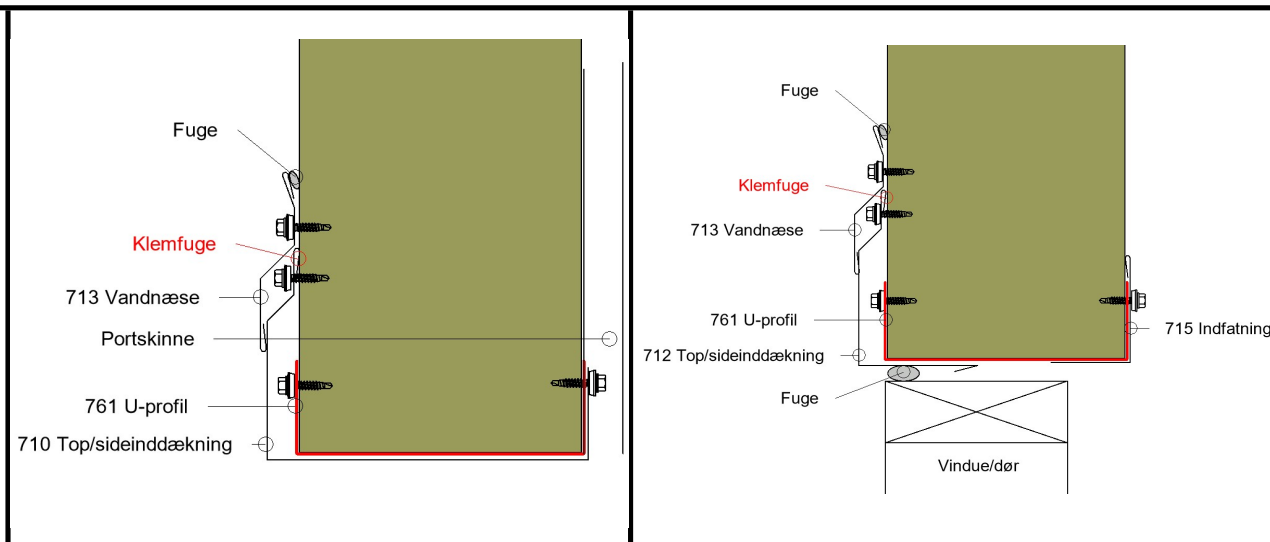

A:
B: 50
C: 50

(A=paneltykkelse +2mm)

(B=std 50 vinduer/døre/porte)

(C=std 50 døre/vinduer - 100 porte)

Antal	Længde	Farve	Ståltykkelse	Info til kunde
		Galv	1,50	

762 - Vinkelprofil 70x70

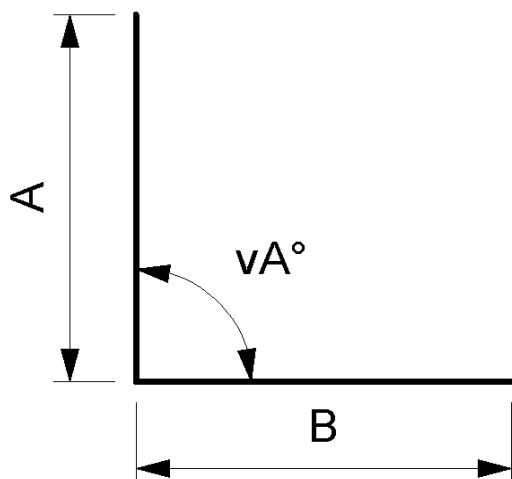
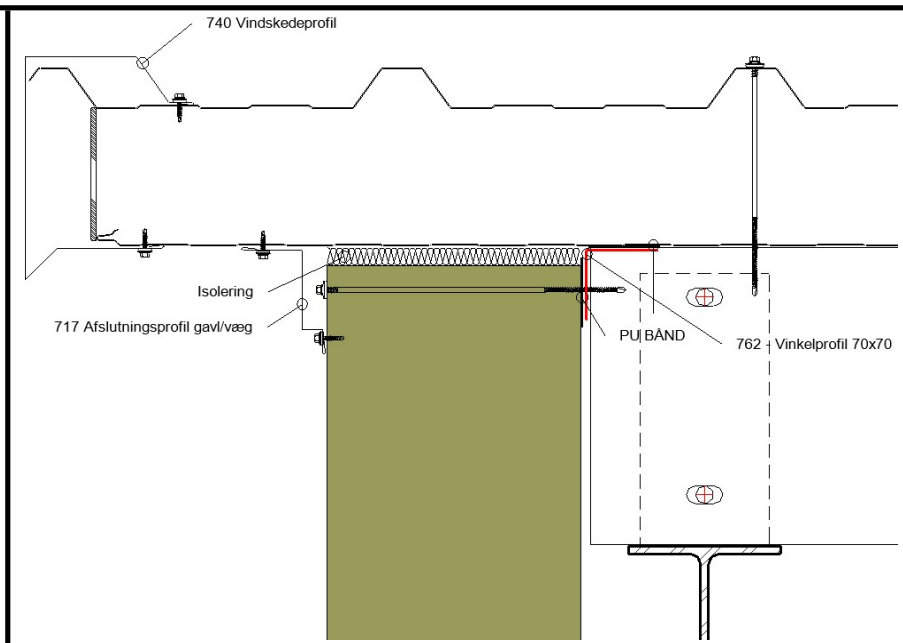

A: 70
 B: 70
 vA: 90°
 (A&B = Std 70mm)

Antal	Længde	Farve	Ståltykkelse	Info til kunde
		Galv	1,50	

763 - Vinkelprofil til konsoljern tagrende (uden udhæng)

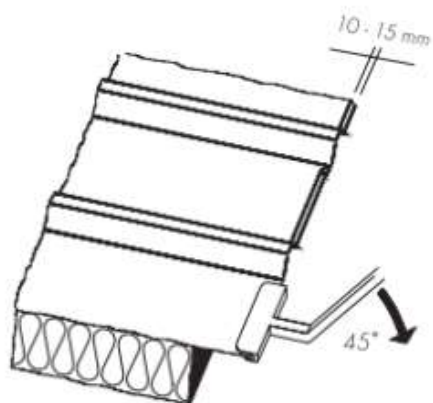

10-15mm bund af panel bukkes for at modvirke tagdryp render op ad!

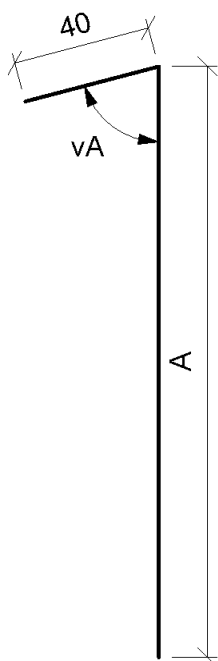
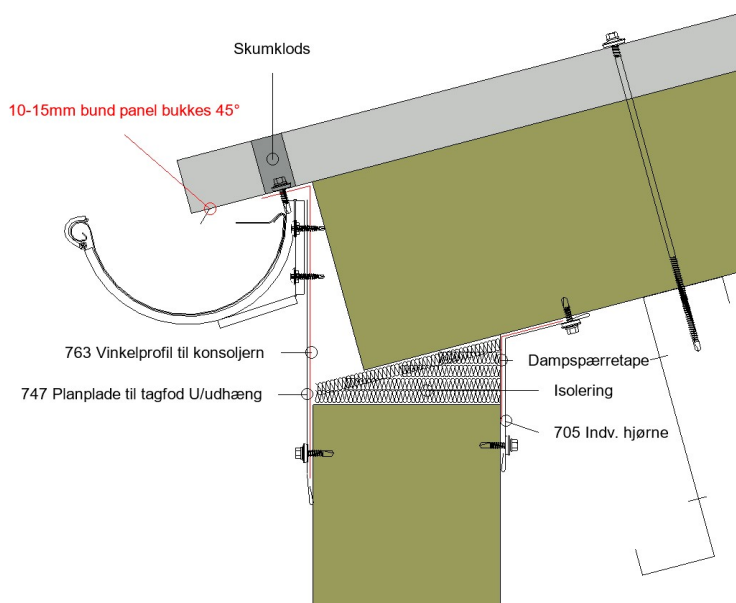

vA: °
A:

Antal	Længde	Farve	Ståltykkelse	Info til kunde
		Galv	1,50	

764 - Z-profil for konsoljern til tagrende

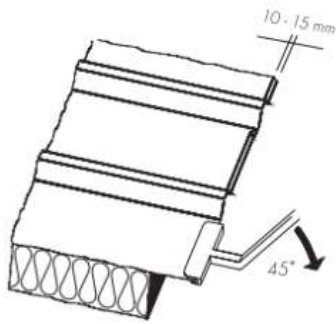

10-15mm bund af panel bukes for at modvirke tagdryp render op ad!

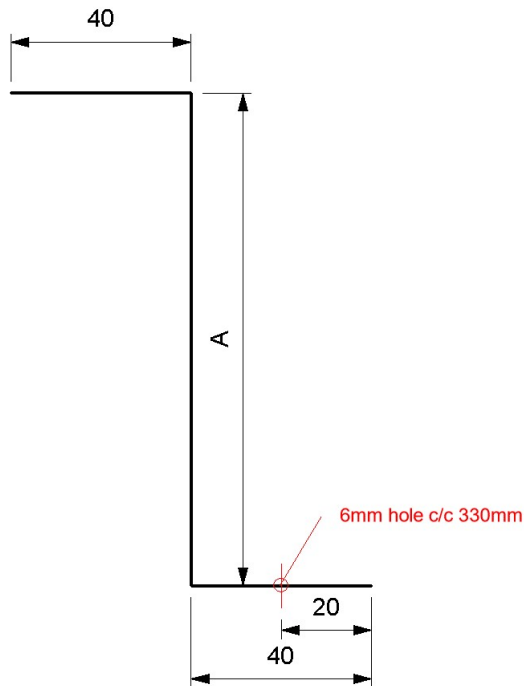
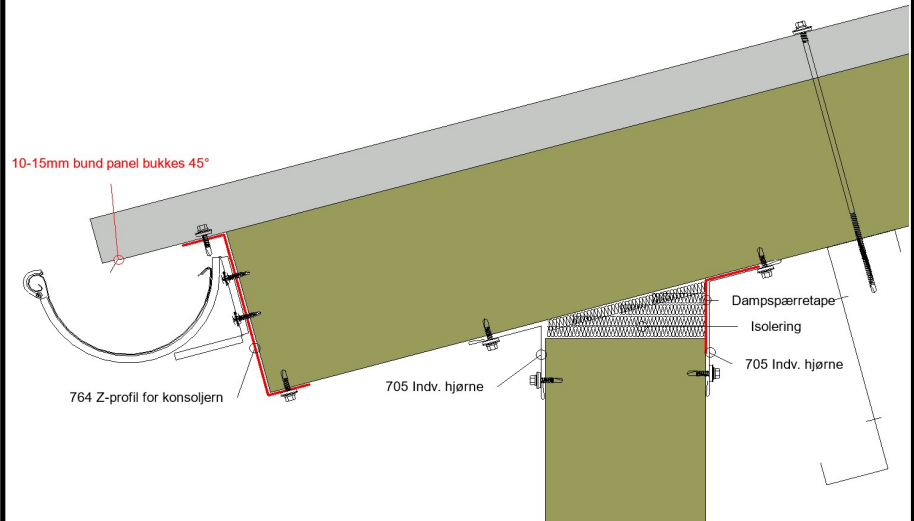

A:
(A= paneltykkelse)

Antal	Længde	Farve	Ståltykkelse	Info til kunde
		Galv	1,50	

765 - Profil for konsoljern til tagrender (40-60mm paneler)

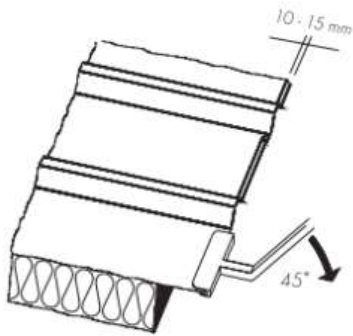

10-15mm bund af panel bukes for at modvirke tagdryp render op ad!

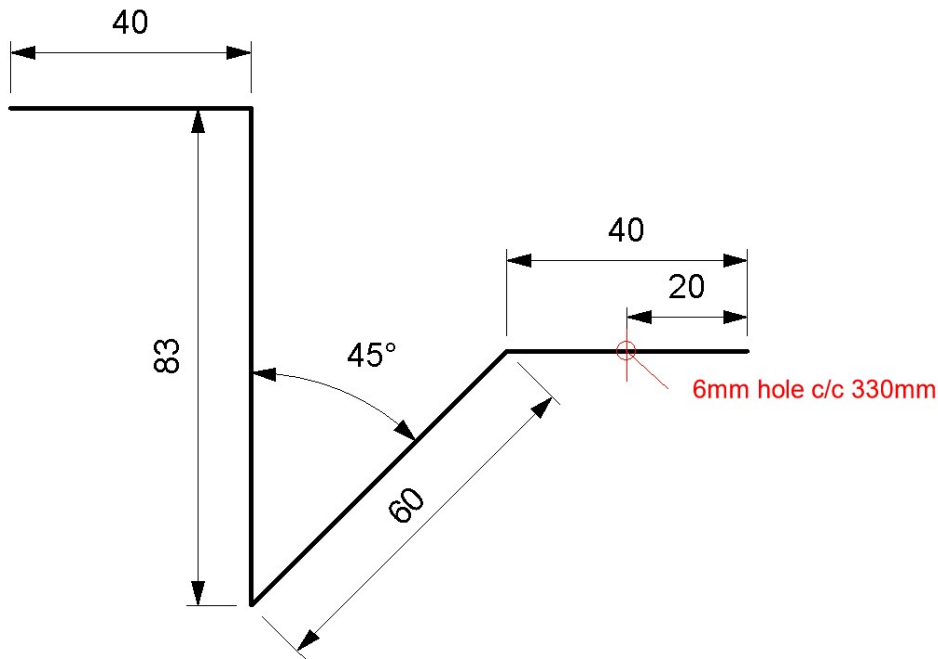
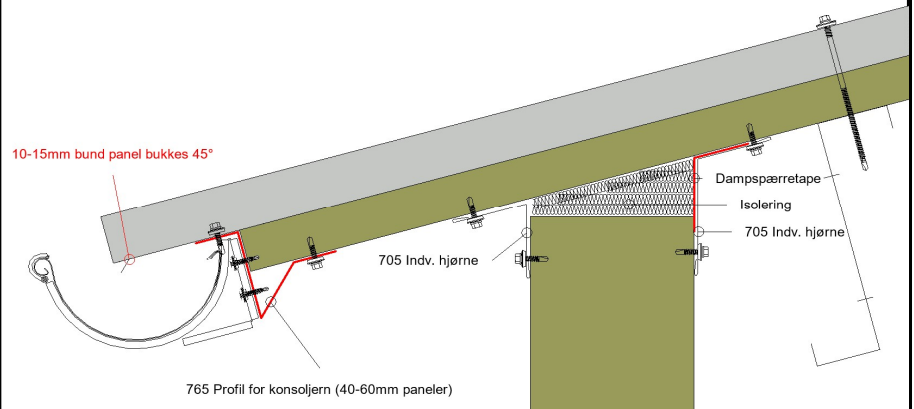

A:
 (40mm Panel A = 83mm)
 (60mm Panel A = 103mm)

Antal	Længde	Farve Galv	Ståltykkelse 1,50	Info til kunde

766 - Underlag for murkrone inddækning type 744/744-B

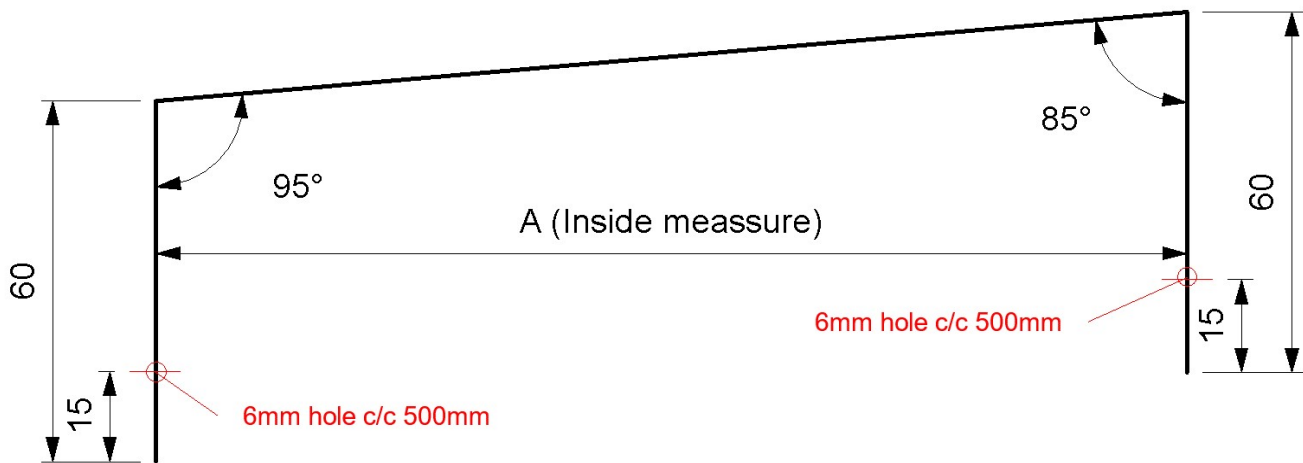
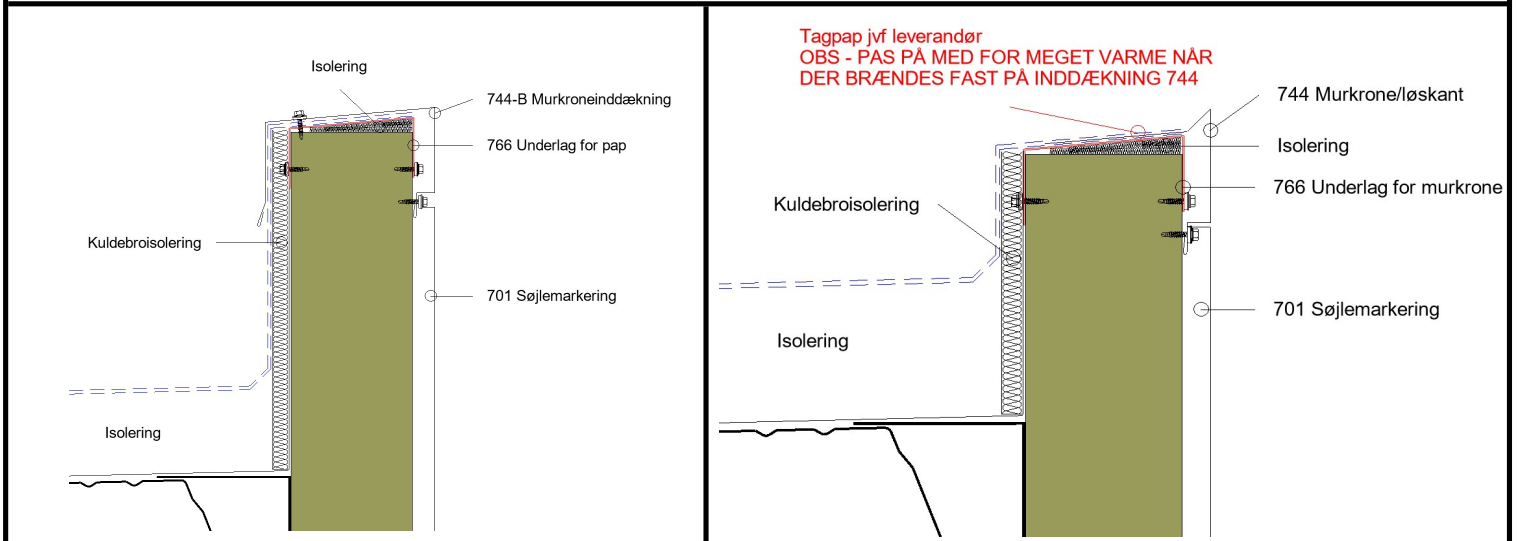

A:
(Paneltykkelse +2mm)

Antal	Længde	Farve	Ståltykkelse	Info til kunde
		Galv	1,00	

Special inddækning type:



--	--

Antal	Længde	Farve	Ståltykkelse	Info til kunde
		Galv	1,50	